

INSTRUCTIONS

LED PL Tube Series - Bypass/Line Voltage

RAB Lighting is committed to creating high-quality, affordable, well-designed and energy-efficient LED lighting and controls that make it easy for electricians to install and end users to save energy. We'd love to hear your comments. Please call the Marketing Department at 888-RAB-1000 or email: marketing@rablighting.com

PLC-9-H-8XX-BYP



SAFETY PRECAUTIONS

WARNINGS:

- Make certain power is OFF before installing or maintaining fixture.
- NOT FOR EMERGENCY LIGHTING

The units covered by this report were intended to retrofit surface mount, Type IC or non-IC, recessed-mount listed, fluorescent luminaires that use maximum one tubular lamp. The minimum lamp compartment dimensions are for the following:

Model Number: PLC-9-H-8XX-BYP

MINIMUM LAMP COMPARTMENT DIMENSIONS [DIAMETER >> HEIGHT] [CM] 15x9 Lamp Quantity: 1

This device complies with Part 15 of the FCC Rules. Operation is subject to the following two conditions:

- (1) this device may not cause harmful interference, and
- (2) this device must accept any interference received, including interference that may cause undesired operation.

PRODUCT FEATURES

- UL certified
- Full glass housing: no aging, yellowing, bending
- Product applications: widely used in residential buildings, offices, shopping malls, supermarkets, hospitals, assembly lines, warehouses, etc. for energy-saving illumination.

INSTALLATION INSTRUCTIONS

Please completely comply with these instructions and notes, to ensure that the product is operated in a safe condition.

Lampholder Wiring Instruction

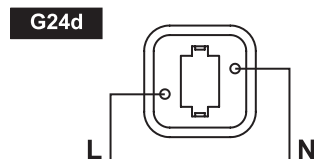
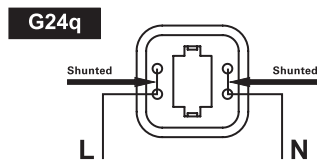

INSTALLATION INSTRUCTIONS (cont'd)

Wiring Instruction - Electronic Ballast

Retrofit luminaire with 1 lamp

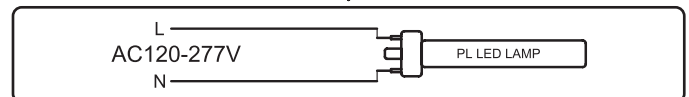
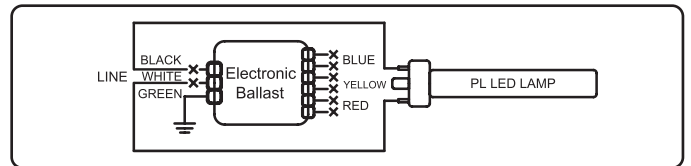

Retrofit luminaire with 2 lamp

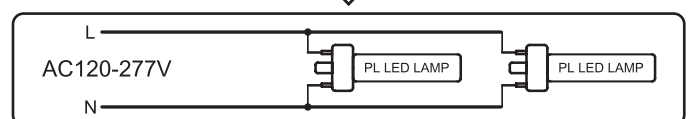
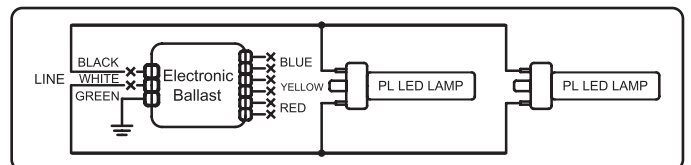

LED PL Tube Series - Bypass/Line Voltage

RAB Lighting is committed to creating high-quality, affordable, well-designed and energy-efficient LED lighting and controls that make it easy for electricians to install and end users to save energy. We'd love to hear your comments. Please call the Marketing Department at 888-RAB-1000 or email: marketing@rablighting.com

INSTALLATION INSTRUCTIONS (cont'd)

Wiring Instruction - Magnetic Ballast

Retrofit luminaire with 1 lamp

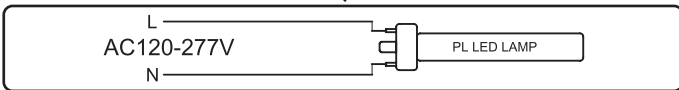
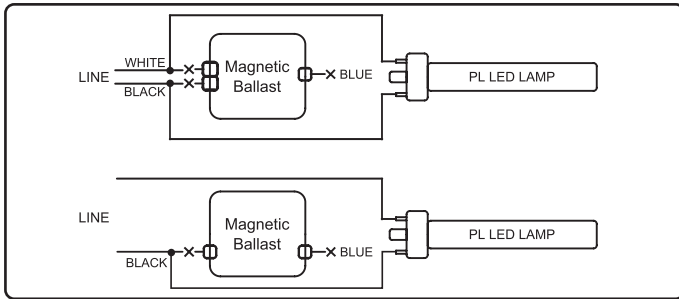

Retrofit luminaire with 2 lamp

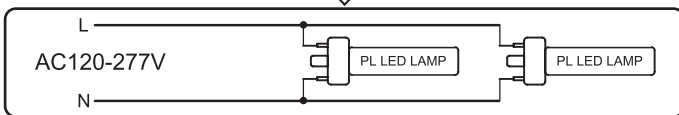
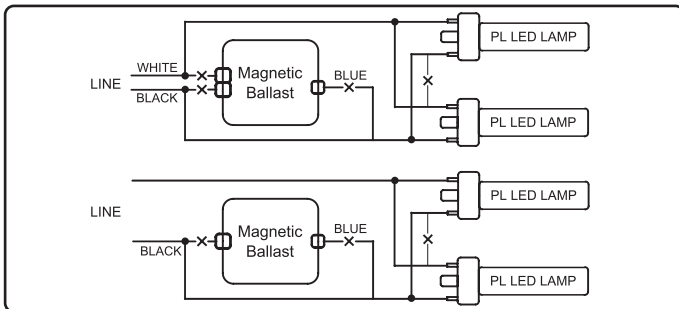

WARNING

RISK OF FIRE OR ELECTRIC SHOCK. LED Retrofit Kit installation requires knowledge of luminaires' electrical systems. If not qualified, do not attempt installation. Contact a qualified electrician.

Install this kit only in luminaires that have the construction features and dimensions shown in the photographs and/or drawing, and where the input rating of the retrofit kit does not exceed the input rating of the luminaire.

To prevent wiring damage or abrasion, do not expose wiring to edges of sheet metal or other sharp objects.

Do not make or alter any open holes in an enclosure of wiring or electrical components during kit installation.

Installers should not disconnect existing wires from lampholder terminals to make new connections at lampholder terminals. Instead installers should cut existing lampholder leads away from the lampholder and make new electrical connections to lampholder lead wires by employing applicable connectors.

THIS RETROFIT KIT IS ACCEPTED AS A COMPONENT OF A LUMINAIRE WHERE THE SUITABILITY OF THE COMBINATION SHALL BE DETERMINED BY AUTHORITIES HAVING JURISDICTION.

INSTRUCTIONS

LED PL Tube Series - Bypass/Line Voltage

RAB Lighting is committed to creating high-quality, affordable, well-designed and energy-efficient LED lighting and controls that make it easy for electricians to install and end users to save energy. We'd love to hear your comments. Please call the Marketing Department at 888-RAB-1000 or email: marketing@rablighting.com

PLC-9-V-8XX-BYP



SAFETY PRECAUTIONS

WARNINGS:

- Make certain power is OFF before installing or maintaining fixture.
- NOT FOR EMERGENCY LIGHTING

The units covered by this report were intended to retrofit surface mount, Type IC or non-IC, recessed-mount listed, fluorescent luminaires that use maximum one tubular lamp. The minimum lamp compartment dimensions are for the following:

Model Number: PLC-9-V-8XX-BYP

MINIMUM LAMP COMPARTMENT DIMENSIONS [DIAMETER >> HEIGHT] [CM] 15.5x18.5 Lamp Quantity: 1

This device complies with Part 15 of the FCC Rules. Operation is subject to the following two conditions:

- (1) this device may not cause harmful interference, and
- (2) this device must accept any interference received, including interference that may cause undesired operation.

PRODUCT FEATURES

- UL certified
- Full glass housing: no aging, yellowing, bending
- Product applications: widely used in residential buildings, offices, shopping malls, supermarkets, hospitals, assembly lines, warehouses, etc. for energy-saving illumination.

INSTALLATION INSTRUCTIONS

Please completely comply with these instructions and notes, to ensure that the product is operated in a safe condition.

Lampholder Wiring Instruction



INSTALLATION INSTRUCTIONS (cont'd)

Wiring Instruction - Electronic Ballast

Retrofit luminaire with 1 lamp

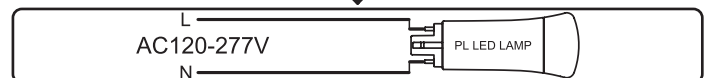
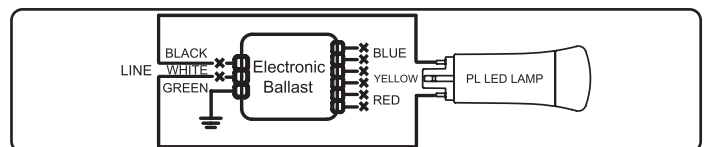

Wiring Instruction - Magnetic Ballast

Retrofit luminaire with 1 lamp

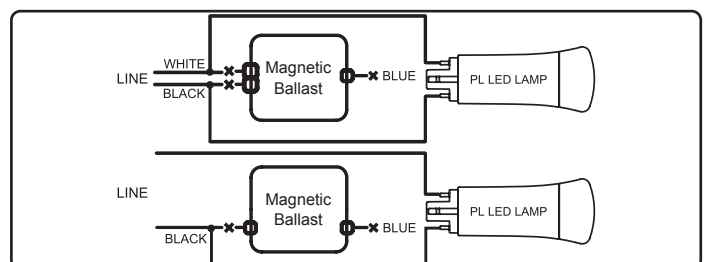

INSTRUCTIONS

LED PL Tube Series - Bypass/Line Voltage

RAB Lighting is committed to creating high-quality, affordable, well-designed and energy-efficient LED lighting and controls that make it easy for electricians to install and end users to save energy. We'd love to hear your comments. Please call the Marketing Department at 888-RAB-1000 or email: marketing@rablighting.com

WARNING

RISK OF FIRE OR ELECTRIC SHOCK. LED Retrofit Kit installation requires knowledge of luminaires' electrical systems. If not qualified, do not attempt installation. Contact a qualified electrician.

Install this kit only in luminaires that have the construction features and dimensions shown in the photographs and/or drawing, and where the input rating of the retrofit kit does not exceed the input rating of the luminaire.

To prevent wiring damage or abrasion, do not expose wiring to edges of sheet metal or other sharp objects.

Do not make or alter any open holes in an enclosure of wiring or electrical components during kit installation.

Installers should not disconnect existing wires from lampholder terminals to make new connections at lampholder terminals. Instead installers should cut existing lampholder leads away from the lampholder and make new electrical connections to lampholder lead wires by employing applicable connectors.

THIS RETROFIT KIT IS ACCEPTED AS A COMPONENT OF A LUMINAIRE WHERE THE SUITABILITY OF THE COMBINATION SHALL BE DETERMINED BY AUTHORITIES HAVING JURISDICTION.