

PROJECT: TYPE:

LOCATION: CAT:

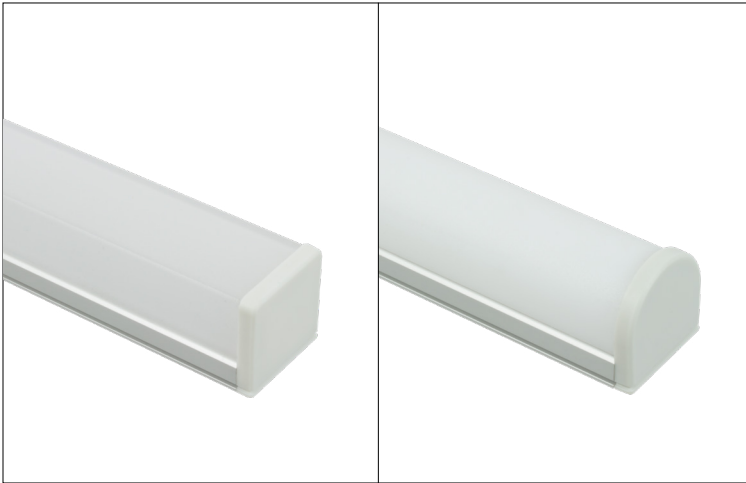

With Squared Lens and End Cap

With Rounded Lens and End Cap

Description

The Turbo extrusion resembles a low-profile T5 luminaire when assembled, allowing two side-by-side rows of tape light (15/32" width or smaller) to boost light output and increase coverage.

Features

- Extruded aluminum construction
- 15/16" wide channel allows for two rows of tape light (7/8" width or smaller)
- Use tape light, end caps, and lens to create a complete fixture (tape light and accessories sold separately)

Mounting

Surface mount via construction adhesive or flat-head counter-sunk screws in holes drilled through extrusion; Requires a 1-1/16" width and 1" height clearance

Applications

Food prep areas, closets, workshops, and offices

Warranty

3 years

Technical Information

Profile Dimensions

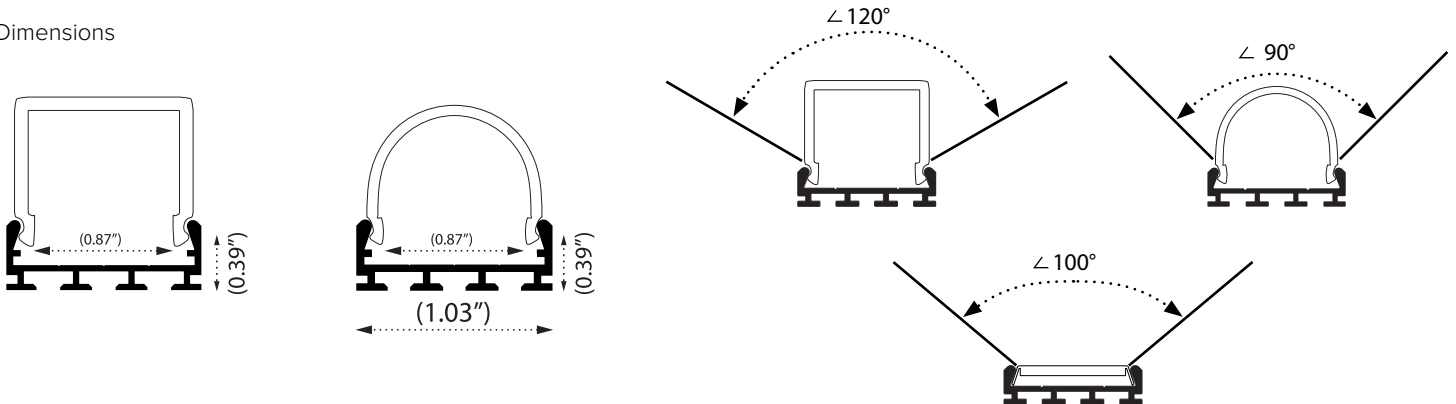

Ordering Information





Turbo Extrusion

MODEL	TYPE	LENGTH
PE	TURBO2	1M

PE-TURBO-1M includes:
 (1) 1M Turbo aluminum extrusion

*Turbo Extrusion is available as special order only
 Please allow up to 2 weeks for order processing.

Accessories

Image	Part Number	Description
	PE-RTURBO-1M	1 meter Rounded polycarbonate lens for Turbo extrusion
	PE-RTURBO-END	Polypropylene plastic rounded end cap for Turbo extrusion (when using PE-RTURBO-1M lens)
	PE-QTURBO-1M	1 meter Squared polycarbonate lens for Turbo extrusion
	PE-QTURBO-END	Polypropylene plastic square end cap for Turbo extrusion (when using PE-QTURBO-1M lens)
	PE-SLOTLENS-2M	2 meter frosted polycarbonate lens for Flange Slot extrusion; UV Resistant/Flame Retardant