



## SURFACE MOUNT DRUM



- > Choose from 5 fixture styles with multiple diameters.
- > Flexible: flexWATT allows you to select between 4 wattages & flexCOLOR between 3 colors...all in the same fixture!
- > Future-proof: Powered by easily replaceable & upgradeable LEDSR G2 light engine.
- > Optional emergency battery back-up and control options.

↑  
powered by  
the LEDSR  
G2 light  
engine

flexWATT  
STANDARD



flexCOLOR  
STANDARD

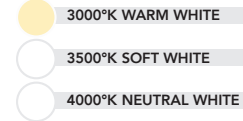

flexCONTROL  
OPTIONAL

ORDER CONTROL READY,  
BASIC CONTROL OR LG  
ADVANCED CONTROL

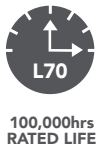
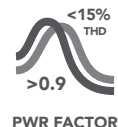
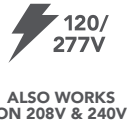

PART #	UPC	FLEXWATTAGE	LUMENS	LPW	FLEXCOLOR
RP-DRU-11N-14L-40K-WC-G2-A	844006022617	6W/10W/16W/22W	780-3124	130-142	3000K/3500K/4000K
RP-DRU-11N-14L-40K-WC-G2-OC1-A	844006022631	6W/10W/16W/22W	780-3124	130-142	3000K/3500K/4000K
RP-DRU-14N-14L-40K-WC-G2-A	844006022624	6W/10W/16W/22W	780-3124	130-142	3000K/3500K/4000K
RP-DRU-14N-14L-40K-WC-G2-OC1-A	844006022648	6W/10W/16W/22W	780-3124	130-142	3000K/3500K/4000K
RP-DRD-14N-14L-40K-WC-G2-A	844006040673	6W/10W/16W/22W	780-3124	130-142	3000K/3500K/4000K
RP-DRD-14N-14L-40K-WC-G2-OC1-A	844006040680	6W/10W/16W/22W	780-3124	130-142	3000K/3500K/4000K
RP-DRD-18N-14L-40K-WC-G2-A	844006040697	6W/10W/16W/22W	780-3124	130-142	3000K/3500K/4000K
RP-DRD-18N-14L-40K-WC-G2-OC1-A	844006040703	6W/10W/16W/22W	780-3124	130-142	3000K/3500K/4000K





# SURFACE MOUNT DRUM

## CCT SELECTION

LUMEN SELECTION	830	835	840
8L	780LM, 6W	780LM, 6W	816LM, 6W
14L	1370LM, 10W	1440LM, 10W	1370LM, 10W
23L	2256LM, 16W	2240LM, 16W	2352LM, 16W
31L	2970LM, 22W	3080LM, 22W	3124LM, 22W

### DRO - OUTDOOR DRUM 12"

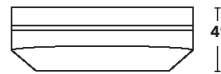
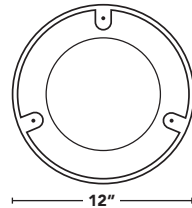

- > Vandal resistant and watertight/wet-raised.
- > Strong rigid lens made from high transmission, UV blocking polycarbonate.
- > Strong white polycarbonate base.
- > Available in 12in diameter.

PART #	UPC	FLEXWATTAGE	LUMENS	LPW	FLEXCOLOR	ENERGY STAR	QUICK SHIP
RP-DRO-12N-14L-40K-WC-G2	844006015763	6W/10W/16W/22W	780-3124	130-142	3000K/3500K/4000K	✓	✓
RP-DRO-12N-14L-40K-WC-G2-OC1	844006019983	6W/10W/16W/22W	780-3124	130-142	3000K/3500K/4000K	✓	✓

### DRT - TOUGH DRUM 13"

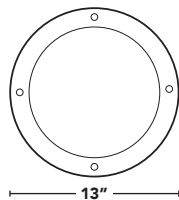

- > Vandal resistant and watertight/wet-raised.
- > Strong rigid lens made from high transmission, UV blocking polycarbonate.
- > Thick metal, brushed nickle plated base, trim rings and hardware.
- > Available in 13in diameters. Contact us for custome paint colors such as white, brass or bronze

PART #	UPC	FLEXWATTAGE	LUMENS	LPW	FLEXCOLOR	ENERGY STAR	QUICK SHIP
RP-DRT-13N-14L-40K-WC-G2	844006015794	6W/10W/16W/22W	780-3124	130-142	3000K/3500K/4000K	✓	✓
RP-DRT-13N-14L-40K-WC-G2-OC1	844006010492	6W/10W/16W/22W	780-3124	130-142	3000K/3500K/4000K		✓



# SURFACE MOUNT DRUM

## DRU - UTILITY DRUM 11" OR 14"

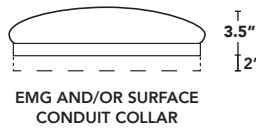
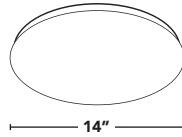
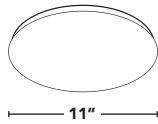

- > Flexible lens made from high transmission, UV blocking acrylic plastic.
- > Thick metal, white painted base.
- > Lens attaches to metal base via twist lock - no tools required.
- > Available in 11in and 14in diameters.

PART #	UPC	FLEXWATTAGE	LUMENS	LPW	FLEXCOLOR	ENERGY STAR	QUICK SHIP
RP-DRU-11N-14L-40K-WC-G2-A	844006022617	6W/10W/16W/22W	780-3124	130-142	3000K/3500K/4000K	✓	✓
RP-DRU-11N-14L-40K-WC-G2-OC1-A	844006022631	6W/10W/16W/22W	780-3124	130-142	3000K/3500K/4000K	✓	✓
RP-DRU-14N-14L-40K-WC-G2-A	844006022624	6W/10W/16W/22W	780-3124	130-142	3000K/3500K/4000K	✓	✓
RP-DRU-14N-14L-40K-WC-G2-OC1-A	844006022648	6W/10W/16W/22W	780-3124	130-142	3000K/3500K/4000K	✓	✓

## DRD - DESIGNER DRUM 14" OR 18"

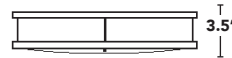
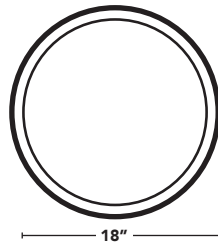
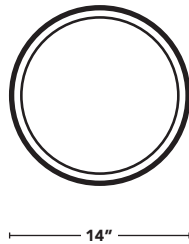

- > Flexible lens made from high transmission, UV blocking acrylic plastic.
- > Thick metal, brushed nickel plated base, trim rings and hardware.
- > Available in 14 and 18 in diameters.
- > Contact us for customer paint colors such as white, brass or bronze.

PART #	UPC	FLEXWATTAGE	LUMENS	LPW	FLEXCOLOR	ENERGY STAR	QUICK SHIP
RP-DRD-14N-14L-40K-WC-G2-A	844006040673	6W/10W/16W/22W	780-3124	130-142	3000K/3500K/4000K	✓	✓
RP-DRD-14N-14L-40K-WC-G2-OC1-A	844006040680	6W/10W/16W/22W	780-3124	130-142	3000K/3500K/4000K	✓	✓
RP-DRD-18N-14L-40K-WC-G2-A	844006040697	6W/10W/16W/22W	780-3124	130-142	3000K/3500K/4000K	✓	✓
RP-DRD-18N-14L-40K-WC-G2-OC1-A	844006040703	6W/10W/16W/22W	780-3124	130-142	3000K/3500K/4000K	✓	✓



# SURFACE MOUNT DRUM



### HOW DOES IT WORK?

Our exclusive LED driver is designed to operate at 90%+ efficiency at each wattage setting. Standard drivers would have much lower efficiency as low as 60% and would result in poor performance and reduced efficacy.

### WHAT ARE THE WATTAGE CHOICES?

Please reference this table and the ordering guide on the last page of the cut sheet.

FLEXWATT TURN DIAL POSITION				
STYLE	0	1	2	3
LEDCR	6W (8L)	10W (14L)	16W (23L)	22W (31L)

### HOW EASY IS IT TO SET?

Simply slide off the driver door, adjust the 4-position turn dial with a small, flat-head screw driver, and replace the door. Quick and easy. Can be "locked-out" to prevent field-adjustability if desired.

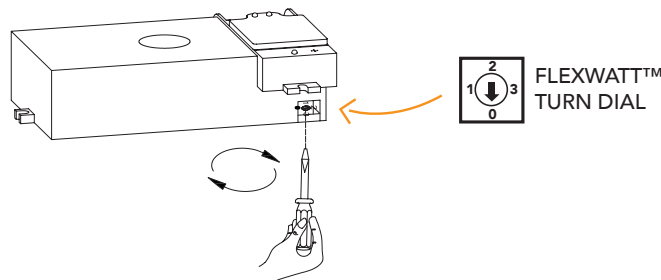

### HOW DOES IT WORK?

We select the highest efficacy, multiple color LED diodes from quality suppliers, and mount them on the same circuit board. A proprietary LED binning process ensures color consistency between fixtures. The FlexColor technology controller ensures the correct color is selected, every time.

### WHAT ARE THE COLOR CHOICES?

3000k, 3500k and 4000k. Please reference this table and the ordering guide on the last page of the cut sheet.

FLEXCOLOR SLIDE SWITCH POSITION		
TOP	MIDDLE	BOTTOM
3000K	3500K	4000K

### HOW EASY IS IT TO SET?

Adjust the 3-position slide switch with your finger. Quick and easy. Can be "locked-out" to prevent field-adjustability if desired.

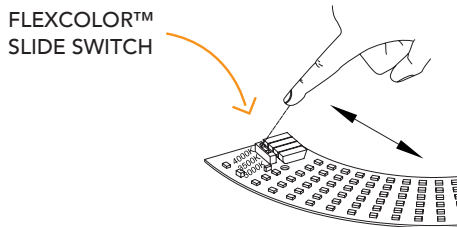

12v Aux - 50mA  
10V DIM-to-OFF

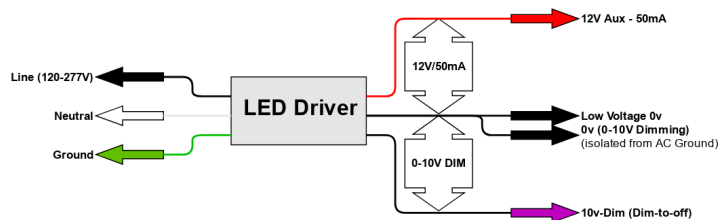



# SURFACE MOUNT DRUM

CUT-OUT IN CENTER OF DRIVER ALLOWS FOR THREADED RODS

INCOMING POWER QUICK DISCONNECT LOCATED ON TOP OF CHASSIS FOR EASY AND SAFE WIRING.

MULTIPLE CHASSIS CUT-OUTS FOR FLEXIBLE WIRING OPTIONS

OPTIONAL INTEGRATED HIGH/LOW MOTION AND DAYLIGHT SENSOR. COMPLETELY ADJUSTABLE AND HIDDEN BEHIND THE FIXTURE LENS

5KVA DRIVER HOUSING. MEETS UL1598C REGULATIONS

CURVED LED BOARDS CAN EXPAND TO FIT SMALL TO LARGE FIXTURES

KEYHOLE SLOTS AND MULTIPLE HOLES FOR FLEXIBLE MOUNTING OPTIONS

STRONG RARE EARTH MAGNETS FOR EASY INSTALLATION

**CONTROL OPTIONS**

**CONTROL READY**

DRIVER

10V DIM

12V POWER

All LEDCR/SR models come standard as factory enabled to add controls at the factory, in the field or at a later date. Driver comes with 10V dimming and 12V DC power wiring.

**BASIC CONTROL**

OCC SENSOR

Integrated high frequency, high/low motion and daylight sensor. Can be mounted behind glass or plastic lens. Purchase optional remote control to adjust settings.

**ORDERING CODES**  
SENSOR = OCC / RC = HNSIII REMOTE

**ADVANCED WIRELESS CONTROL**

MAGNUM INSULATIONS

avi-on

PHILIPS

LUTRON

We partner with Magnum, avi-on, Philips, Lutron and other intelligent wireless lighting control systems. Allows for occupancy sensing, daylight harvesting, grouping, scheduling, high-end trim and more. Adjust settings via iPhone/Android apps. Contact us for

**CONTACT US FOR ORDERING CODES**

**EASILY RETROFIT THESE FIXTURE STYLES, AND MORE!**

LEDGR-G2-9IN/SURFACE MOUNT

LEDGR-G2-9IN/SURFACE MOUNT

LEDGR-G2-9IN/SCONCE





# SURFACE MOUNT DRUM

## SENSOR OPTIONS: OCC / OCCLR

- > OCC - Standard high/low motion sensor.  
Remote: IR12
- > OCCLR - Limited range high/low motion sensor.  
Remote: IR12

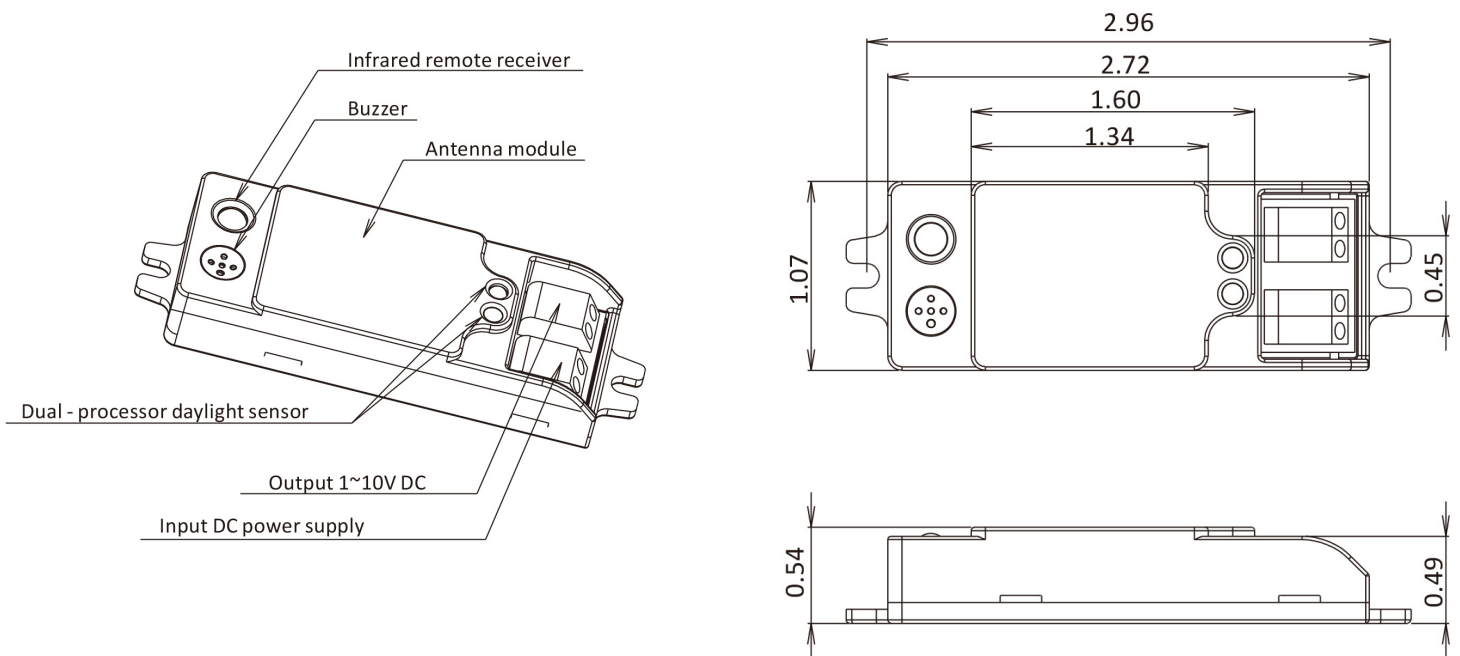

- > Occupancy sensor w/ daylight hold-off.
- > Powered by 12V DC LED driver from fixture - provided by the LED power supply.
- > High frequency radar occupancy sensor.
- > Infrared remote control available (sold separately).
- > Uses less than 0.1W in standby mode.



# SURFACE MOUNT DRUM

## DETECTION PATTERN OCC (STANDARD OPTION)

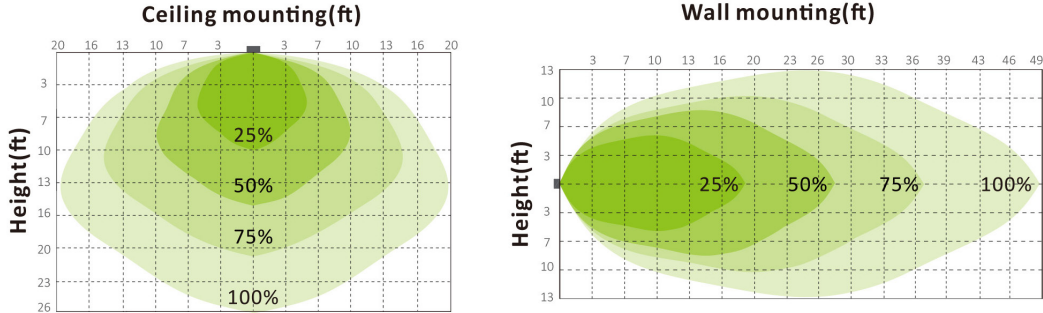

## DETECTION PATTERN OCCLR (LIMITED RANGE)

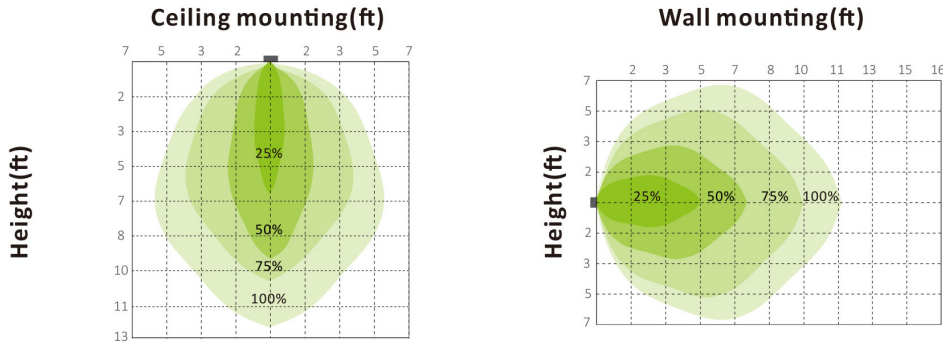

## DAYLIGHT MONITORING FUNCTION

This sensor can tell the difference between natural light and artificial light (lamp) from behind the diffuser, switch on automatically (even without movements) when the ambient light is below the target value, and then switch off automatically whenever the artificial light is not required (ambient light is bright enough).

Note: Lux-Off sampling time - 30s; Lux-On sampling time - 10s

Lux-On function will only operate without motion when standby is set to + ∞.

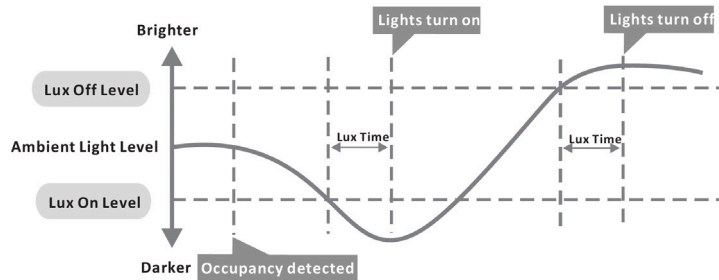





# SURFACE MOUNT DRUM

SENSOR OPTIONS: OCC / OCCLR



### Permanent ON/OFF function

Press "POWER" button, sensor is disabled.

\*press "Auto", "Reset" or "Ambient learn" to quit this mode.



### Dim +/-

Press "Dim" button to automatically dim up or down the light brightness during hold-time from 10% to 100%. Another press to lock it down when desired brightness is achieved.

\*after desired brightness is locked down, if user wants to dim again reversely, just press the "Dim" button again and then lock down the new brightness again.



### Sensor mode

Press "Auto" button, the sensor starts to work and all settings remain the same as the latest status before the sensor was disabled.



### Reset function

Press "Reset" button, all settings go back to factory default settings.

\* Factory default settings--

- Sensitivity=100%
- Daylight sensor=disable
- Hold time=5min
- Twilight time=+∞
- Twilight level=30%



### Ambient learn

Press "Ambient learn" button, the latest surrounding lux value overwrites previous lux value learned, and set as the daylight threshold. This feature enables the fixture to function well in any real application circumstance.



### Test mode

"Test mode" is for testing purpose only, for users to check the functionality and choose the desired detection range. The sensor goes to test mode automatically after pressing this button.

Users can quit this mode by pressing "ON/OFF", "Reset", or any button of "Hold time". The sensor settings are changed accordingly.

\* Test mode defaulted settings--

- Daylight sensor=disable
- Hold time=3s
- Twilight time=N/A
- Twilight level=N/A



### IR12

Note:

- The buzzer short beeps (~0.5s) ONCE when sensor successfully receives RC signal after pressing any buttons except for "Ambient learn".
- The buzzer short beeps (~0.5s) TWICE to start learning ambient lux after pressing "Ambient learn". Then followed by a long beep (~1s) to indicate the success of ambient learning.
- When "twilight level" set at 0%, it becomes ON/OFF control.





# SURFACE MOUNT DRUM

## SENSOR OPTIONS: OCCRF (SIMPLE GROUPING SENSOR)

- > OCCRF - Standard high/low motion sensor.  
Remote: IR13

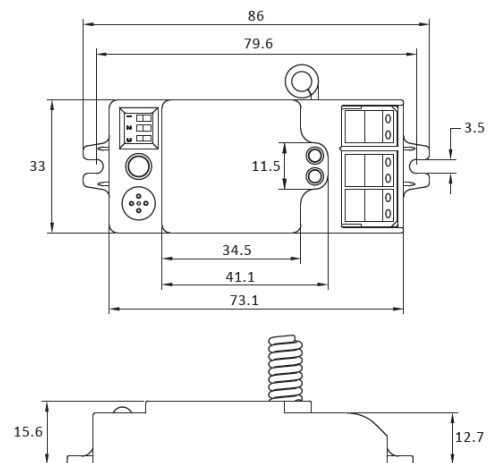
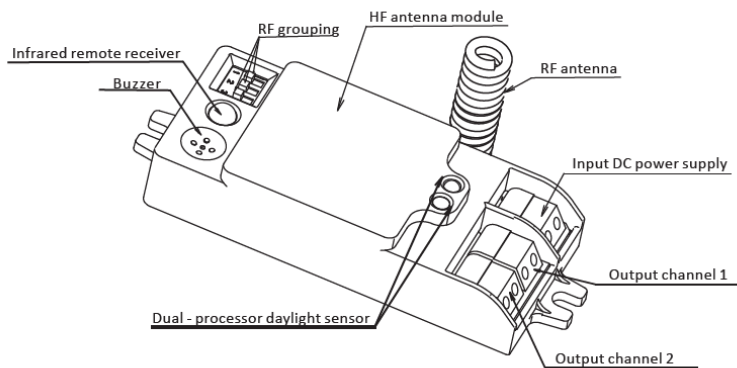

- > Simple grouping motion sensor w/ daylight hold-off.
- > Powered by 12V DC - provided by the LED power supply.
- > Max 150 ft. grouping range.
- > Ideal for stairways, parking garages & hallways.
- > Grouping by remote or dip switch (infrared remote control sold separately).
- > Uses less than 0.1W in standby mode.



# SURFACE MOUNT DRUM

## DETECTION PATTERN OCCRF

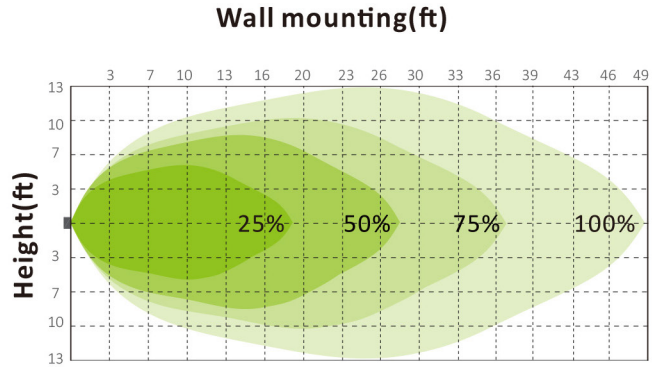
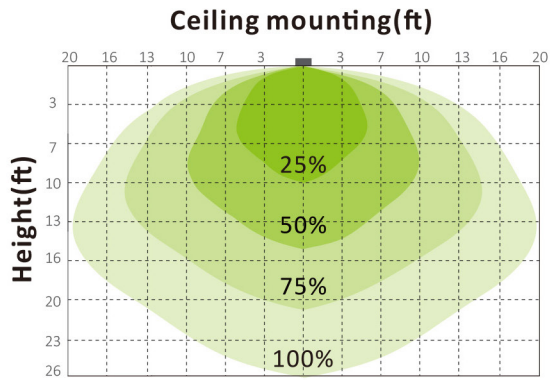

## DAYLIGHT MONITORING FUNCTION

This sensor can tell the difference between natural light and artificial light (lamp) from behind the diffuser, switch on automatically (even without movements) when the ambient light is below the target value, and then switch off automatically whenever the artificial light is not required (ambient light is bright enough).

Note: Lux-Off sampling time - 30s; Lux-On sampling time - 10s

Lux-On function will only operate without motion when standby is set to + ∞.

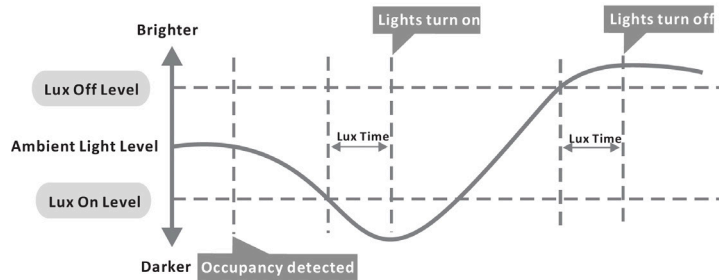



# SURFACE MOUNT DRUM

## SENSOR OPTIONS: OCCRF (SIMPLE GROUPING SENSOR)



### OCC OFF function

Press "OCC OFF" button, the motion sensor will be disabled.

\*press "OCC ON", "Reset" or "Ambient" to re-activate the motion sensor.



### Dim

Press "Dim" button to automatically dim up or down the light brightness during hold-time from 10% to 100%. Another press to lock it down when desired brightness is achieved.

\*After desired brightness is locked down, if user wants to dim again reversely, just press the "Dim" button again and then lock down the new brightness again.



### OCC ON function

Press "OCC ON" button, the sensor starts to work and all settings remain the same as the latest status before the light was switched on / off.



### Reset function

Press "Reset" button, all sensor settings go back to factory default settings.

\* Factory default setting:

- Sensitivity=100%
- Daylight sensor=disable
- Hold time=90s
- Twilight time=5min
- Twilight level=10%
- CCT=Neutral



### Ambient learn

Press "Ambient learn" button, the latest surrounding lux value overwrites previous lux value learned, and set as the daylight threshold. This feature enables the fixture to function well in any real application circumstance.



### Test mode

"Test mode" is for testing purpose only, for users to check the functionality and choose the desired detection range. The sensor goes to test mode automatically after pressing this button.

Users can quit this mode by pressing "ON/OFF", "Reset", or any button of "Hold time". The sensor settings are changed accordingly.

- \* Test mode defaulted settings--
- Daylight sensor=disable
- Hold time=3s
- Twilight time=N/A
- Twilight level=N/A

In this mode, when used for on/off control, after motion detected, sensor enters into a cycle of 3s on and 2s off.

In this mode, when used for tri-level dimming control, after motion detected, sensor enters into a cycle of 3s on and 2s off (0.5s soft off + 1.5s off).

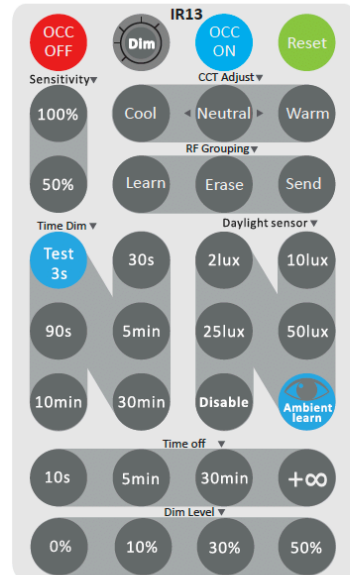

### Note:

- The buzzer short beeps (~0.5s) ONCE when sensor successfully receives RC signal after pressing any buttons except for "Ambient learn".
- The buzzer short beeps (~0.5s) TWICE to start learning ambient lux after pressing "Ambient learn" Then followed by a long beep (~1s) to indicate the success of ambient learning.
- When "twilight level" set at 0%, it becomes ON/OFF control.
- Function zone of "CCT Adjust" is invalid for this model.



# SURFACE MOUNT DRUM

SENSOR OPTIONS: OCCRF (SIMPLE GROUPING SENSOR)

## RF Grouping ( via remote control )

- Learn Short press "Learn" button to the receiver unit to start grouping mode, the receiver unit will beep quickly (every second for 3min). This grouping mode will last for 3min, second short press on it will quit the grouping mode.
- Send Short press "Send" button to the commander unit, it will beep once to start a 5s RF signal sending, and then beep twice to indicate finish of it. After receiving the RF signal, the receiver unit will beep 1s to indicate the success of grouping.
- Erase Long press "Erase" button for 5s to the sensor unit, it will long beep once, to indicate the success of erasing.

### Note:

1. If you want the sensor to work as both commander and receiver , you need to repeat the "learn" and "send" process again with the identification exchanged.
2. Each receiver can learn up to max. 32 commanders, commanders added beyond 32pcs will automatically substitute earlier ones.
3. Before using the remote control for grouping, you have to position the grouping DIP switch at OFF - OFF - OFF. (default from factory)

### Steps for grouping with remote control:

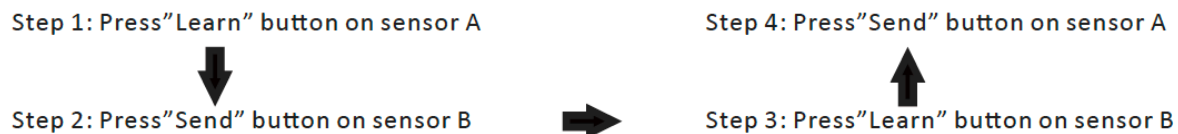

## Fast RF Grouping ( via DIP switch )

By simply selecting the same channel on each sensor unit, the grouping is quickly and automatically completed. Totally 7 channels are available for fast grouping.

\*Channel OFF - OFF - OFF is not for fast grouping, it is for remote control grouping only.



# SURFACE MOUNT DRUM

## SENSOR OPTIONS: OCCRF (SIMPLE GROUPING SENSOR)

### ILLUSTRATION FOR TYPICAL PARKING GARAGE APPLICATION

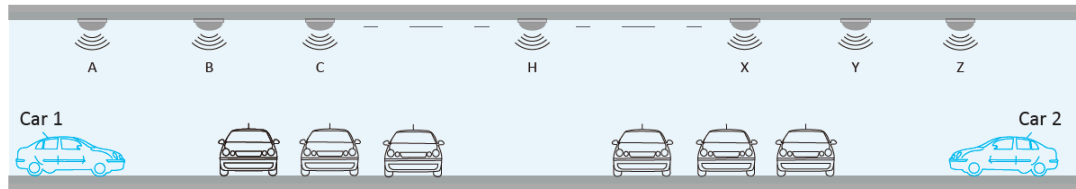

With sufficient daylight, sensor will not be triggered by motion, all lamps are off.

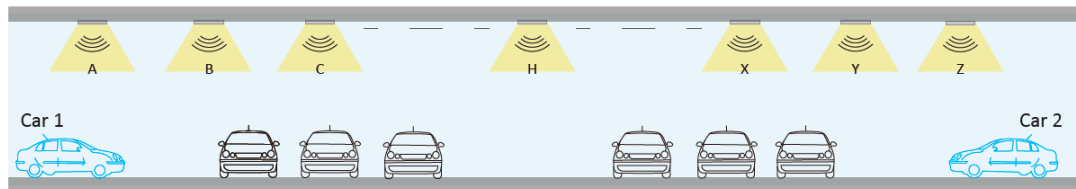

With insufficient natural light, either car 1 or car 2 enters the garage, sensor A or Z will be triggered on, and send RF signal simultaneously to all grouped sensors, all lamps will be 100% ON.

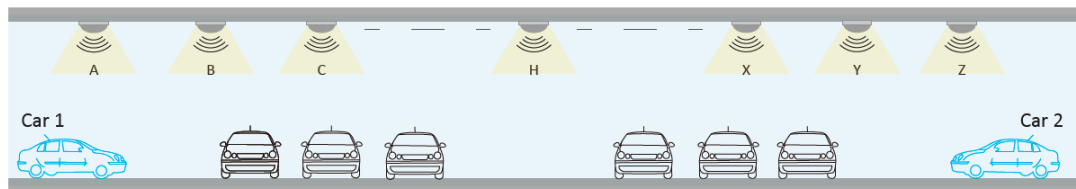

After the hold-time, the whole grouped lamps will dim to pre-defined dimming level (e.g., 10%) if no further movement detected.

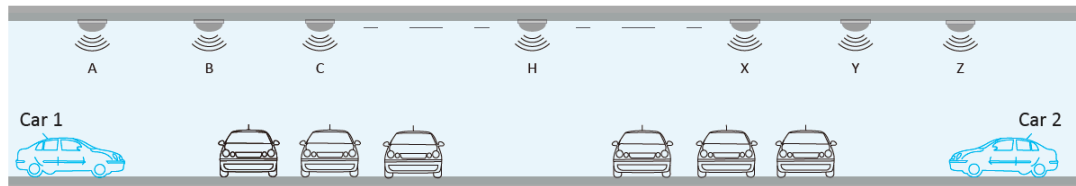

The whole grouped lamps will switch off automatically after the stand-by period if no further movement detected.

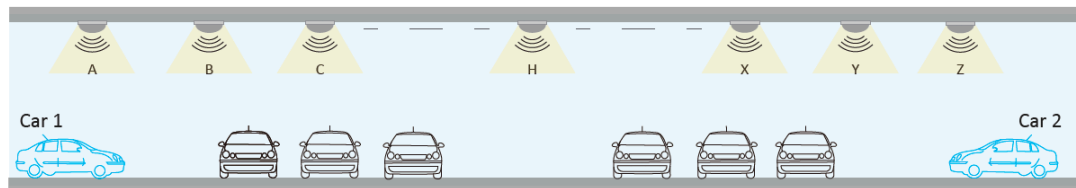

Thanks to the daylight monitoring function, even no movement detected, the sensor will automatically switch on the lamp to pre-defined stand-by dimming level (e.g., 10%), as long as the natural light is below pre-defined lux threshold. (to achieve this unique function stand-by period of the sensor has to be set at  $+\infty$ ).

**\*Note:**

1. The RF transmission is a triggering signal only to activate the grouped sensors, each sensor will act based on their own settings.
2. Thanks to the Dual-processor technology, the built-in daylight sensor will shut off the lamp in real time regardless of any movements as long as the detected natural light is higher than pre-defined lux threshold.