

Project Name:	Type:
Part Number:	Date:

# SINGLE ENDED BYPASS T8

## FEATURES

- T8 tube 2' / 3' / 4' / U bent
- CCT: 3000K, 3500K, 4000K, 5000K
- Ultra high efficacy version up to 167lm/W available
- Built-in universal voltage driver, operates on 120-277V line input
- Opaque glass provides glare free, even lighting with a 310° light emitting area
- Suitable for damp locations and totally enclosed fixtures
- NSF (National Sanitation Foundation) certified for Food Zone (Non-Contact), Splash, and Non-Food Zones
- Fixture operating temperature: -4°F to 95°F (-20°C to 35°C)
- Lamp ambient temperature: -4°F to 113°F (-20°C to 45°C)
- Rated lifetime(L70) up to: 60,000hrs
- 5 year limited warranty\* / 10 year available  
(see EXTENDED WARRANTIES table for information)

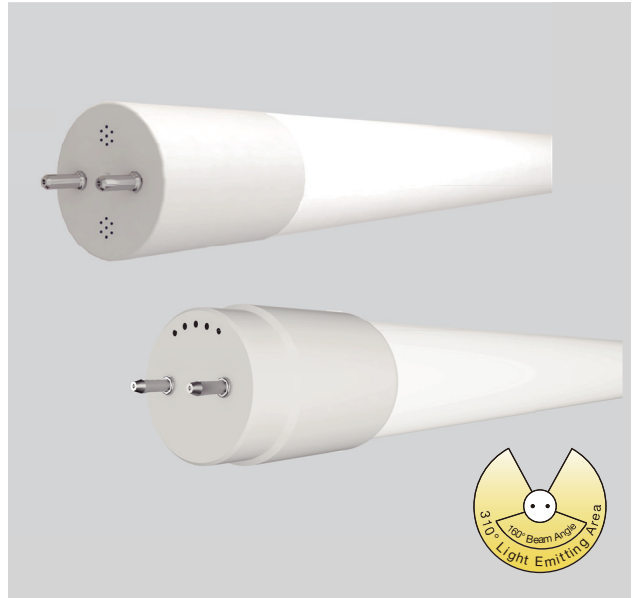

101322



## SPECIFICATIONS

Product	Model	Nominal Length	Equiv.	Input Voltage	Life (hrs)	Wattage	Lumens	CCT	CRI	Efficacy (LPW)	Power Factor	THD	Beam Angle	Dim.***	DLC / NSF
36961	8T8/2F/830/BYP/RC	2'	17W	120-277V	60,000	8	1,000	3000K	82	125	0.9	<20%	160°	Yes	√ / √
36962	8T8/2F/835/BYP/RC	2'	17W	120-277V	60,000	8	1,000	3500K	82	125	0.9	<20%	160°	Yes	√ / √
36963	8T8/2F/840/BYP/RC	2'	17W	120-277V	60,000	8	1,050	4000K	82	131	0.9	<20%	160°	Yes	√ / √
36964	8T8/2F/850/BYP/RC	2'	17W	120-277V	60,000	8	1,050	5000K	82	131	0.9	<20%	160°	Yes	√ / √
36965	12T8/3F/830/BYP/RC	3'	25W	120-277V	60,000	12	1,500	3000K	82	125	0.9	<20%	160°	Yes	√ / √
36966	12T8/3F/835/BYP/RC	3'	25W	120-277V	60,000	12	1,500	3500K	82	125	0.9	<20%	160°	Yes	√ / √
36967	12T8/3F/840/BYP/RC	3'	25W	120-277V	60,000	12	1,550	4000K	82	129	0.9	<20%	160°	Yes	√ / √
36968	12T8/3F/850/BYP/R	3'	25W	120-277V	60,000	12	1,550	5000K	82	129	0.9	<20%	160°	Yes	√ / √
98379	10.5T8/4F/830/BYP	4'	32W	120-277V	60,000	10.5	1,650	3000K	82	157	0.9	<20%	160°	Yes	√ / √
98380	10.5T8/4F/835/BYP	4'	32W	120-277V	60,000	10.5	1,650	3500K	82	157	0.9	<20%	160°	Yes	√ / √
98381	10.5T8/4F/840/BYP	4'	32W	120-277V	60,000	10.5	1,750	4000K	82	167	0.9	<20%	160°	Yes	√ / √
98382	10.5T8/4F/850/BYP	4'	32W	120-277V	60,000	10.5	1,750	5000K	82	167	0.9	<20%	160°	Yes	√ / √
36969	13T8/4F/830/BYP/RC	4'	32W	120-277V	60,000	13	1,700	3000K	82	131	0.9	<20%	160°	Yes	√ / √
36970	13T8/4F/835/BYP/RC	4'	32W	120-277V	60,000	13	1,700	3500K	82	131	0.9	<20%	160°	Yes	√ / √
36971	13T8/4F/840/BYP/RC	4'	32W	120-277V	60,000	13	1,750	4000K	82	134	0.9	<20%	160°	Yes	√ / √
36972	13T8/4F/850/BYP/RC	4'	32W	120-277V	60,000	13	1,750	5000K	82	134	0.9	<20%	160°	Yes	√ / √
98476	14.5T8/4F/835/BYP	4'	32W	120-277V	60,000	14.5	2,100	3500K	82	145	0.9	<20%	160°	Yes	√ / √
98473	14.5T8/4F/840/BYP	4'	32W	120-277V	60,000	14.5	2,200	4000K	82	152	0.9	<20%	160°	Yes	√ / √
98474	14.5T8/4F/850/BYP	4'	32W	120-277V	60,000	14.5	2,200	5000K	82	152	0.9	<20%	160°	Yes	√ / √
36973	16T8/4F/840/BYP/RC	4'	32W	120-277V	60,000	16	2,100	4000K	82	131	0.9	<20%	160°	Yes	√ / √
36974	16T8/4F/850/BYP/RC	4'	32W	120-277V	60,000	16	2,100	5000K	82	131	0.9	<20%	160°	Yes	√ / √
36975	20.5T8/4F/840/BYP/R	4'	40W**	120-277V	60,000	20.5	2,950	4000K	82	141	0.9	<20%	160°	Yes	√ / √
36976	20.5T8/4F/850/BYP/R	4'	40W**	120-277V	60,000	20.5	2,950	5000K	82	141	0.9	<20%	160°	Yes	√ / √
98162	17T8U6/830/BYP/R	U-6	32W	120-277V	60,000	17	2,100	3000K	82	124	0.9	<20%	160°	Yes	√ / N.A.
35460	17T8U6/835/BYP/R	U-6	32W	120-277V	60,000	17	2,100	3500K	82	124	0.9	<20%	160°	Yes	√ / N.A.
98163	17T8U6/840/BYP/R	U-6	32W	120-277V	60,000	17	2,300	4000K	82	135	0.9	<20%	160°	Yes	√ / N.A.
98164	17T8U6/850/BYP/R	U-6	32W	120-277V	60,000	17	2,300	5000K	82	135	0.9	<20%	160°	Yes	√ / N.A.

\* Please visit [www.greencreative.com](http://www.greencreative.com) for Limited Warranty terms.  
 \*\* Replace 40W T10/T12 lamps or 32W T8 lamps.  
 \*\*\* Please Consult Factory for Dimming Options.



# SINGLE ENDED BYPASS T8

## DIMENSION & WEIGHT

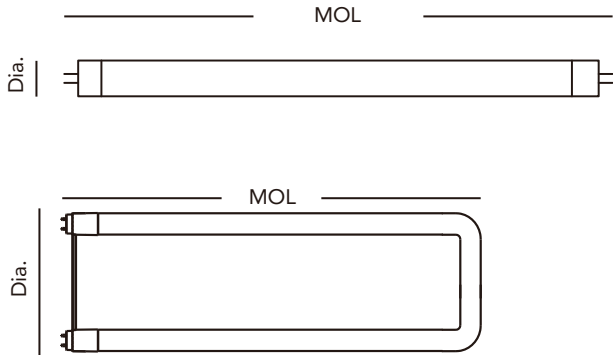

Model	Base	MOL	Dia.	Weight
8T8/2F/8xx/BYP/RC	G13	23-3/4"	1.0"	0.24lb
12T8/3F/8xx/BYP/RC	G13	35-3/4"	1.0"	0.32lb
10.5T8/4F/8xx/BYP	G13	47-13/16"	1.0"	0.57lb
13T8/4F/8xx/BYP/RC	G13	47-13/16"	1.0"	0.47lb
14.5T8/4F/8xx/BYP	G13	47-13/16"	1.0"	0.57lb
16T8/4F/8xx/BYP/RC	G13	47-13/16"	1.0"	0.47lb
20.5T8/4F/8xx/BYP/R	G13	47-13/16"	1.0"	0.53lb
17T8U6/8xx/BYP/R	G13	22-7/16"	7-1/16"	0.53lb

Where xxx means 824-965 which indicates CRI and color temperature

## INSTALLATION

Diagram A – Non-Shunted

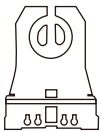
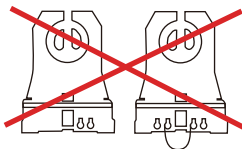
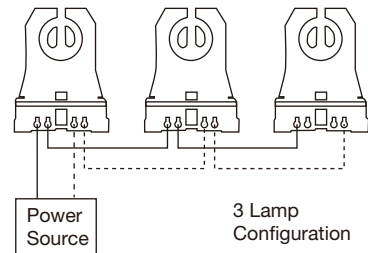

Diagram B – Shunted



This lamp is compatible with non-shunted lamp holder ONLY.



### TUBE

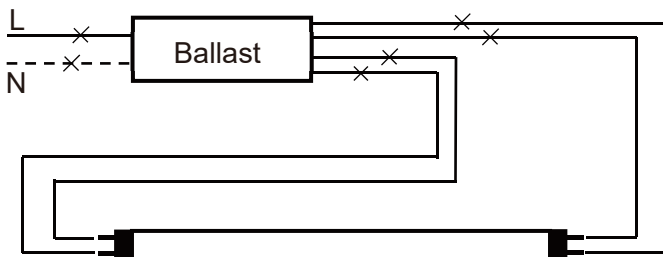

Step 1. Cut all wires connected to the existing ballast, remove the ballast.

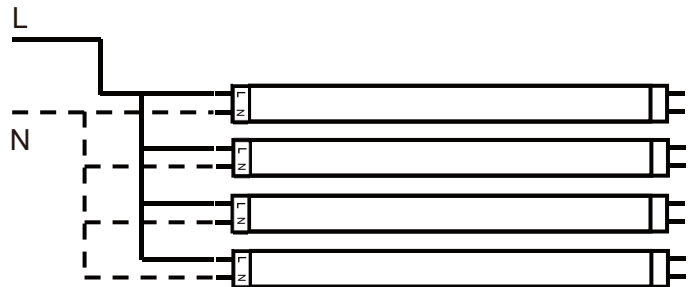

Step 2. If shunted lamp holders are used in the existing fixture, replace them with non-shunted holders first. Wire the holders and lamps according to the diagram.



# SINGLE ENDED BYPASS T8

## INSTALLATION

### U-BENT

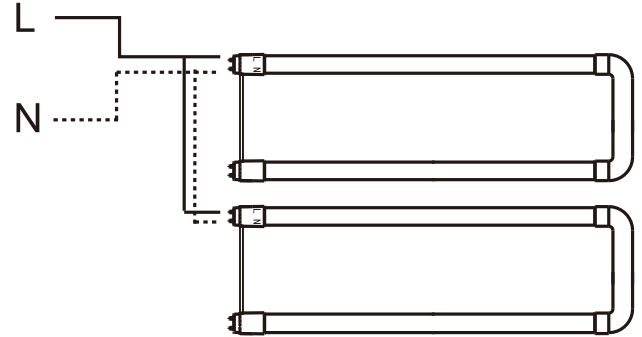
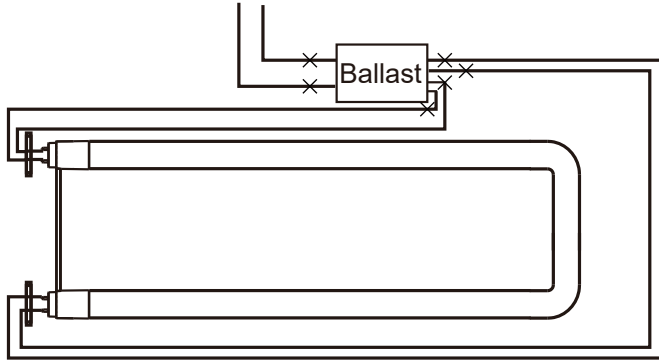

## ACCESSORY ORDERING INFORMATION

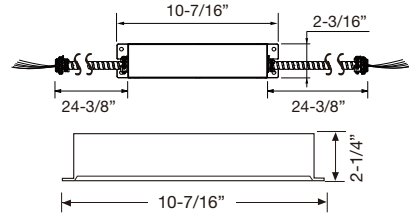
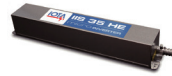
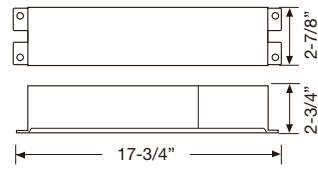
Product	Model	Description	Pictures	Dimensions
98003	23EMDRIVER	California Title 20 Compliant 23W Emergency LED Driver (Field Installation)		 <p>10-7/16" (length) 2-3/16" (width) 24-3/8" (mounting hole spacing) 2-1/4" (height)</p>
58012	35EMINVERTER***	35W Emergency Inverter (Field Installation)		 <p>17-3/4" (length) 3" (height) 2-3/4" (mounting hole spacing)</p>
58013	35EMINVERTER/CEC	California Title 20 Compliant 35W Emergency Inverter (Field Installation)		 <p>17-3/4" (length) 2-7/8" (height) 2-3/4" (mounting hole spacing)</p>

\*\*\*Does not meet Title 20 appliance requirements, not for use in California

## EXTENDED WARRANTIES\*\*\*\*

Model	Description*****
8T8/2F/BYP/10YEARWARRANTY	10 Year warranty for 8T8/2F/8xx/BYP/yy
12T8/3F/BYP/10YEARWARRANTY	10 Year warranty for 12T8/3F/8xx/BYP/yy
10.5T8/4F/BYP/10YEARWARRANTY	10 Year warranty for 10.5T8/4F/8xx/BYP/yy
13T8/4F/BYP/10YEARWARRANTY	10 Year warranty for 13T8/4F/8xx/BYP/yy
14.5T8/4F/BYP/10YEARWARRANTY	10 Year warranty for 14.5T8/4F/8xx/BYP/yy
16T8/4F/BYP/10YEARWARRANTY	10 Year warranty for 16T8/4F/8xx/BYP/yy
20.5T8/4F/BYP/10YEARWARRANTY	10 Year warranty for 20.5T8/4F/8xx/BYP/yy
17T8/U6/BYP/10YEARWARRANTY	10 Year warranty for 17T8U6/8xx/BYP/yy

\*\*\*\* Warranty based on a maximum of 4,368 annual operating hours (per year for ten years) and exposure to a maximum fixture operating temperature of 80°F / 27°C.

\*\*\*\*\* xx – Refers to the CCT yy – Refers to model generations within the same nominal performance. Typically blank, 'R', or 'RC'



# SINGLE ENDED BYPASS T8

CERTIFICATION INFORMATION		
Product	Model	DLC ID#
98379	10.5T8/4F/830/BYP	PLQIQC0PLP7P
98380	10.5T8/4F/835/BYP	PLM4U8W5M90Z
98381	10.5T8/4F/840/BYP	PL299HA1S71O
98382	10.5T8/4F/850/BYP	PL00PTXQ2MZM
98476	14.5T8/4F/835/BYP	PLOM0T0BMPO6
98473	14.5T8/4F/840/BYP	PLHPIVUMTFJH
98474	14.5T8/4F/850/BYP	PLUKSTKW1NC6
98162	17T8U6/830/BYP/R	PL0K2H4PRESH
35460	17T8U6/835/BYP/R	PLD92RAO4HH7
98163	17T8U6/840/BYP/R	PLDUCDLE7QGO
98164	17T8U6/850/BYP/R	PL3ODG0X88EX
36965	12T8/3F/830/BYP/RC	S-FCWQ4V
36966	12T8/3F/835/BYP/RC	S-FGKDLN
36967	12T8/3F/840/BYP/RC	S-1TC8F6
36968	12T8/3F/850/BYP/R	S-YP2TBC
36969	13T8/4F/830/BYP/RC	S-FV6N7I
36970	13T8/4F/835/BYP/RC	S-AMCU60
36971	13T8/4F/840/BYP/RC	S-5KWXFI
36972	13T8/4F/850/BYP/RC	S-6OEJKX

Note: All rights reserved. All sizes and specifications are subject to change at any time without notice.