

Project Name:	Part Number:	Type:
---------------	--------------	-------

SQ

CURVED WRAP



407-478-3759
www.ilp-inc.com



FEATURES

- 2ft, 4ft and 8ft configurations
- Sleek curved profile frosted acrylic impact resistant lens
- .040" aluminum pre-painted white housing
- Ceiling, wall or suspension mounting options
- Multiple dimming & sensor options to fully control occupied & unoccupied light levels
- Suitable for installing in continuous runs
- ASLFMB Adjustable Sliding Fixture Mounting Box option will provide a pendant-ready solution perfect for retrofits when pendant locations are unknown or inconsistent
- 3000K - 5000K CCT
- 0-10V Dimmable Driver (100% - 10%)
- 120-277V Universal Voltage
- Calculated L70>100,000 hrs @ 25°C per TM-21-11
- 5 Year Warranty (std); 10 Year Warranty Optional
- DesignLights Consortium Qualified Luminaire
- ETL Listed for Damp Location



SUITABLE APPLICATIONS

- Office
- Hospitals
- Education
- Hallways
- Work Station Task Lighting
- Multipurpose

ORDERING GUIDE:

SERIES	WATTS	DRIVER	CCT	WARRANTY
SQ2 2ft Curved Wrap	2L	U 120-277V	50	BLANK 5 Year
	3L		40	10YR ¹ 10 Year
			35	
SQ4 4ft Curved Wrap	2L		30	
	4L			
	6L			
SQ8 8ft Curved Wrap	4L			
	8L			
	12L			

OPTIONS		CONTROLS OPTIONS	
Factory Installed		Basic	
CORDx	Cord (x = ft)	FIOS ⁵	On/Off Occupancy Sensor
SR	Sensor Ready Driver	USB ⁵	Allows the end user to manually select the unoccupied dimming level and adjust the high-end trim if desired.
DR	DALI-Ready Driver	BDxx ⁵	Preset Bi-Level Dim Sensor (xx=%eg.20,30)
BLD	Bi-level Dimming Driver (2 hot leads)		
DIM1	1% Dimming Driver		
EM5	5W LED Factory Installed Battery Backup		
EM5/HE ²	5W LED Factory Installed Battery Backup		
EM7	7W LED Factory Installed Battery Backup		
EM7/HE ²	7W LED Factory Installed Battery Backup		
EM10	10W LED Factory Installed Battery Backup		
EM10/HE ²	10W LED Factory Installed Battery Backup		
EM10/HE-SD ²	10W Factory Installed Self Diagnostic Battery Backup		
EM12	12W LED Factory Installed Battery Backup		
ASLFMB ¹²	Adjustable Sliding Fixture Mounting Box system (with alignment bracket)		
RACEWAY/3WIRE ³	3 wire raceway wiring harness for continuous wiring through fixtures (non-dim function)		
RACEWAY/5WIRE ³	5 wire raceway wiring harness for continuous wiring through fixtures		
SD480 ¹³	480V Step Down Transformer		
SD347 ¹³	347V Step Down Transformer		
Ship With Accessories		Advanced	
WC ¹³	11 GA Wire Cage	ES ^{5,6}	EasySense Grouping Sensor
FMB ^{9,10}	Fixture Mounting Box	5E/CU/IL ⁵	Enlighted 5E Individual Lighting (IL) Sensor with Control Unit
HUB 3/4 ^{9,11}	Conduit Hub 3/4" for pendant mount	5E/CU/CL ⁵	Enlighted 5E Connected Lighting (CL) Sensor with Control Unit
HB-XX-18Y-PAD	Y-Toggle Cable System (xx = in)	5E/CU/IOT ⁵	Enlighted 5E Internet of Things (IOT) Sensor with Control Unit
ALBR	Alignment Bracket (used to align fixtures mounted in continuous rows)	5E/5W/IL ⁵	Enlighted 5E Individual Lighting (IL) Sensor w/ Aux Driver / 5 Wire Connection
ES/WWS/DR	EasySense Dual Rocker Wireless Wall Switch	5E/5W/CL ⁵	Enlighted 5E Connected Lighting (CL) Sensor w/ Aux Driver / 5 Wire Connection
ES/PCD ⁷	Pre-installed app on controlled device for commissioning	5E/5W/IOT ⁵	Enlighted 5E Internet of Things (IOT) Sensor w/ Aux Driver / 5 Wire Connection
		VDO ^{5,8}	Lutron Vive DFCSJ-OEM-OCC (Daylight & Occupancy)
		VRF ^{5,8}	Lutron Vive DFCSJ-OEM-RF (RF Only)

¹Contact factory for more details

²CEC Title 20 Compliant

³Used only when mounting in continuous rows

⁴End Mounted Sensor

⁵Integral to fixture

⁶Must be used with ES/PCS for commissioning

⁷One needed per project

⁸Must be used with SR Driver

⁹One needed per 4ft section

¹⁰Must use with HUB 3/4

¹¹Must use with FMB

¹²Not available with 2ft models

¹³Does not qualify for DLC

LED SYSTEMS INFO ¹	3000K CCT		3500K CCT		4000K CCT		5000K CCT		Watts ²	CRI	Ambient Temperature Range
	Part #	Lumens	Efficacy	Lumens	Efficacy	Lumens	Efficacy	Lumens			
SQ2-2L-U-XX	2,043 lm	126 lm/W	2,063 lm	128 lm/W	2,084 lm	129 lm/W	2,125 lm	131 lm/W	16 W	>80	-4°F to 122°F
SQ2-3L-U-XX	2,651 lm	119 lm/W	2,677 lm	120 lm/W	2,704 lm	121 lm/W	2,757 lm	124 lm/W	22 W	>80	-4°F to 122°F
SQ4-2L-U-XX	2,202 lm	144 lm/W	2,247 lm	146 lm/W	2,278 lm	148 lm/W	2,340 lm	152 lm/W	15 W	>80	-4°F to 113°F
SQ4-4L-U-XX	4,060 lm	138 lm/W	4,117 lm	142 lm/W	4,174 lm	144 lm/W	4,288 lm	148 lm/W	29 W	>80	-4°F to 113°F
SQ4-6L-U-XX	5,501 lm	128 lm/W	5,582 lm	130 lm/W	5,659 lm	131 lm/W	5,866 lm	135 lm/W	43 W	>80	-4°F to 113°F
SQ8-4L-U-XX	4,574 lm	144 lm/W	4,620 lm	145 lm/W	4,665 lm	146 lm/W	4,757 lm	149 lm/W	32 W	>80	-4°F to 113°F
SQ8-8L-U-XX	7,715 lm	133 lm/W	7,792 lm	134 lm/W	7,869 lm	135 lm/W	8,023 lm	138 lm/W	58 W	>80	-4°F to 113°F
SQ8-12L-U-XX	10,500 lm	121 lm/W	10,605 lm	123 lm/W	10,710 lm	124 lm/W	10,920 lm	126 lm/W	87 W	>80	-4°F to 113°F

¹LED Chips are frequently updated therefore values are nominal

²Electrical data at 25C (77F). Actual wattage may differ by +/-10%.

CONTROLS OPTIONS

BASIC

FIOS

Standard on/off motion sensor. Comes with 360 degree high bay lens, 360 degree low bay lens & aisle lens. 360 degree high bay lens factory installed, unless notified otherwise. Sensor integral to fixture.

USBD

User Selectable Bi-Level Dimming. Allows the end user to manually select the unoccupied dimming level. Once motion is detected, the fixture will return to 100% light output. Sensor integral to fixture.

BDxx

Factory set Bi-Level Dimming. Sensor is set to dim level, as indicated in the "xx" portion of the part number, when the area is unoccupied. Example: BD20 sets the fixture to dim down to 20% lumen output when the area is unoccupied. Once motion is detected, the fixture will return to 100% light output. Sensor integral to fixture.

ADVANCED

EASYSENSE

ES

EasySense sensor combines occupancy sensing, daylight harvesting & institutional tuning in one compact solution. This is an ideal control for any commercial application. Each sensor allows you to turn on/off occupancy and/or daylight harvesting functions as well as set the full light output, background light level, occupancy prolong time, occupancy grace fading time and occupancy time out/hold time. Requires the use of EasySense Pre-Programmed Control Device (ES/PCD), or approved phone from compatibility list; one needed per project.



ES/PCD

Pre-Programmed EasySense Control Device. One needed per project. Sensor can also be programmed with the approved compatible cell phone (listed below).

Compatible Cell Phones:

- LG G3
- LG G Vista
- LG G4
- Samsung S5
- Samsung S5 WHT
- Samsung Note 4
- Samsung Note Edge
- Samsung Galaxy S7 Edge
- Samsung Galaxy J3
- Samsung Galaxy J7
- Samsung S8
- Samsung Galaxy S9
- Nexus 5X
- Nexus 6P

ES/WWS/DR

Optional Wireless / Batteryless Dual Rocker Wall Switch. Up to 100ft range. Functions include: On/Off, dimming and setting of (2) scences for full room control.

Specifications:

- Wireless
- Batteryless
- Dual Rocker
- ZigBee®
- 30-100ft Range

Functions:

1. On (Hold to brighten up)
2. Off (Hold to dim down)
3. Scene 1
4. Scene 2



LUTRON

VDO

Vive DFCSJ-OEM-OCC integral fixture control sensor with daylight & occupancy. Vive provides intuitive programming allowing for maximum flexibility with wireless communication & sensing as desired. Provided with factory installed components only. Lutron system provided by others. Sensor must be used in conjunction with Pico Switch/Dimmer. Cannot be used in conjunction with mechanical on/off power switch. Contact factory for more information.



VRF

Vive DFCSJ-OEM-RF integral fixture control with Radio Frequency (RF) communication. Vive provides intuitive programming allowing for maximum flexibility with wireless communication as desired. Providing with factory installed components only. Lutron system provided by others. Sensor must be used in conjunction with Pico Switch/Dimmer. Cannot be used in conjunction with mechanical on/off power switch. Contact factory for more information.



ENLIGHTED

5E/2W/IL

Bundled System with Enlighted 5E sensor (SU-5E-IL), Control Unit (CU-4E-FM) and Cable (CBL-5E-CU4-30N). Fixtures are controlled based on occupancy & ambient light. Includes ability to group fixtures together and connect to a switch to zone fixtures for group operation. Provided with factory installed components only. Enlighted system provided by others. Contact factory for more information.



5E/2W/CL

Bundled System with Enlighted 5E sensor (SU-5E-CL), Control Unit (CU-4E-FM) and Cable (CBL-5E-CU4-30N). Fixtures are controlled based on occupancy and ambient light. Includes individual lighting control plus connection to Enlighted Energy Manager. The Energy Manager provides data analysis for all data collected by the Enlighted Smart Sensors for energy, occupancy and environment. Provided with factory installed components only. Enlighted system provided by others. Contact factory for more information. (see image above)

5E/2W/IOT

Bundled System with Enlighted 5E sensor (SU-5E-IOT), Control Unit (CU-4E-FM) and Cable (CBL-5E-CU4-30N). Fixtures are controlled based on occupancy and ambient light. Includes individual lighting control plus connection to Enlighted Energy Manager. Energy Manager provides data analysis for all data collected by Enlighted Smart Sensors for energy, occupancy & environment. Additionally, the IOT functionality takes the data access and function beyond just lighting to a wide range of applications beyond the standard connected lighting controls. Provided with factory installed components only. Enlighted system provided by others. Contact factory for more information. (see image above)

SQ

CURVED WRAP

OPTIONS



CORDx

Cords available in 6ft, 10ft, 12ft & 20ft (Inquire for additional options) Plug options available

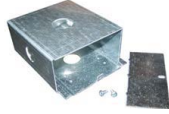

FMB

Includes rigid box to attach to the fixture, provides for dual point mounting to accept a pendant, hook or conduit hub (sold separately)



HUB 3/4

Conduit Hub 3/4" for Pendant Mounting



HB-XX-18Y-PAD

Includes 2 adjustable cable hangers. Available in 60", 120", 180" & 240"



ASLFMB

Adjustable Sliding Fixture Mounting Box system (with alignment bracket)

LINE DRAWINGS

2ft Dimensions

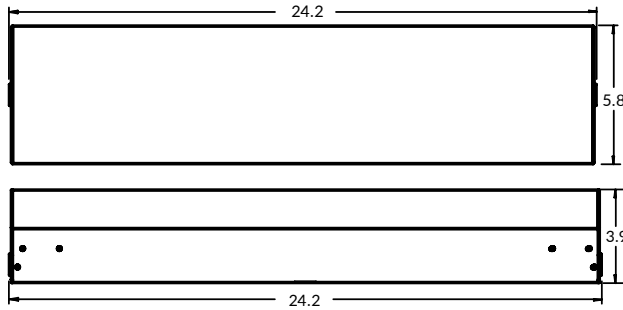
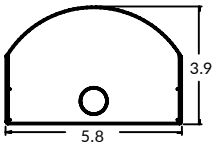

4ft Dimensions

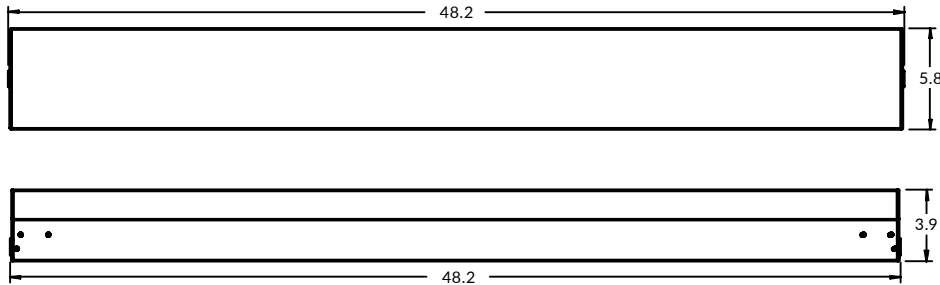
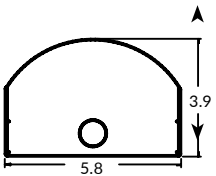

8ft Dimensions

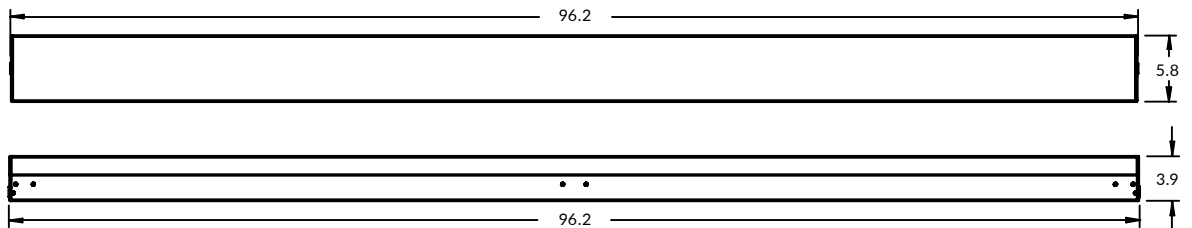
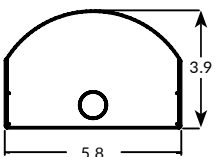

SQ

CURVED WRAP

LINE DRAWINGS

ASLFMB OPION DETAILS

4ft Model

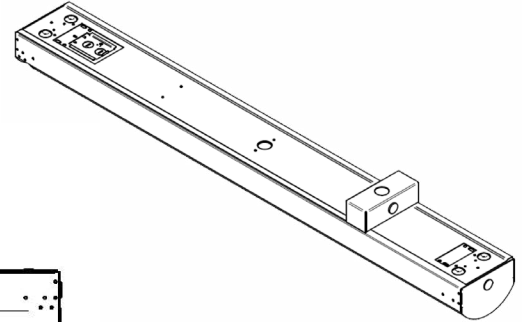
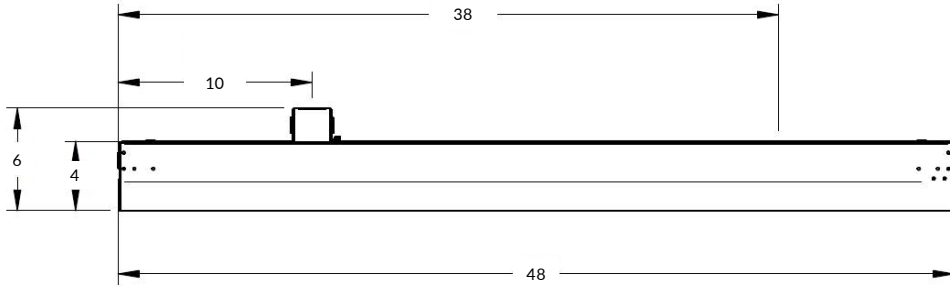

*Dimensions shown above are applicable when the fixtures are the middle units of a continuously mounted set of fixtures.
Please see intallation instructions for limitations on end mounted fixtures.

8ft Model

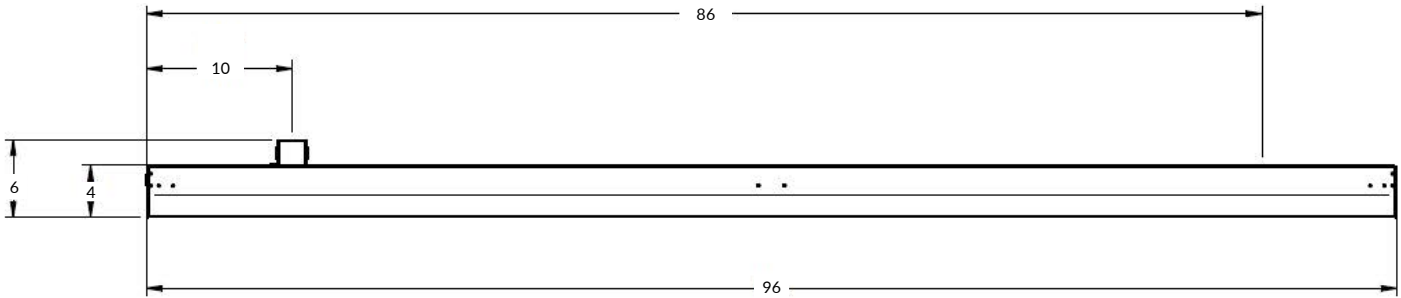

*Dimensions shown above are applicable when the fixtures are the middle units of a continuously mounted set of fixtures.
Please see intallation instructions for limitations on end mounted fixtures.

CURVED WRAP

PHOTOMETRIC DATA

LUMINAIRE DATA	
Part Number	SQ4-4L-U-40
Description	4ft Curved Wrap, 4,000 Lumens, 4000K, Frosted Lens
Fixture Lumens (lm)	4178 lm
Wattage (W)	29W
Efficacy (lm/W)	144 lm/W
Mounting	Pendant
Spacing Criteria	0° = 1.19, 90° = 1.32

ZONAL LUMEN SUMMARY		
Zone	Lumens (lm)	% Fixture
0° - 40°	1587	38%
0° - 60°	2829	68%
0° - 90°	3956	95%
90° - 180°	222	5%
0° - 180°	4178	100%

