

IMPORTANT SAFEGUARDS

When using electrical equipment, basic safety precautions should always be followed including the following:

READ AND FOLLOW ALL SAFETY INSTRUCTIONS

1. This luminaire can only be installed with Cree 120V and 277V cans.
2. Not all existing recessed housings that meet these requirements will be compatible with the LR6. To ensure compatibility, a test installation should be conducted.
3. **DANGER – RISK OF SHOCK – DISCONNECT POWER BEFORE INSTALLATION**
DANGER – RISQUE DE CHOC – COUPER L'ALIMENTATION AVANT L'INSTALLATION
4. **WARNING – Risk of fire or electric shock. installation requires knowledge of luminaires electrical systems. If not qualified, do not attempt installation. Product must be installed in accordance with NEC or your local electrical code. If you are not familiar with these codes and requirements, contact a qualified electrician.**
ATTENTION- Risque d'incendie ou de choc électrique. L'installation exige la connaissance des systèmes électriques pour luminaires. Si non qualifié, ne tentez pas d'installation. Ce produit doit être installé conformément à NEC ou votre code électrique local. Si vous n'êtes pas familier avec ces codes et ces exigences, veuillez contacter un électricien qualifié.
5. **WARNING – Risk of fire or electric shock. Check the existing wiring for damage before installing. Do not install if existing wires are damaged.**
ATTENTION- Risque d'incendie ou de choc électrique. Vérifiez si le câblage existant n'est pas endommagé avant l'installation du kit upgrade LED. Ne pas installer si des fils sont endommagés.
6. **WARNING – To prevent wiring damage or abrasion, do not expose wires to the edge of sheet metal or any other sharp objects.**
ATTENTION - Pour éviter les dégâts de câblage par l'abrasion, ne pas mettre en contact les fils électriques avec des bords de tôle ou d'autres objets pointus.
7. **WARNING – Risk of fire or electric shock. Install this kit only in the luminaires that have the construction features and dimensions shown in the photographs and/or drawings.**
ATTENTION - Risque d'incendie ou de choc électrique. Installez ce kit seulement dans les luminaires qui ont les caractéristiques de construction et les dimensions dans les photographies ou les dessins de la page suivante.
8. **Do not make or alter any open holes in an enclosure of wiring or electrical components during kit installation.**
Ne pas modifier ou faire de trous dans une boîte de câblage ou compartiment électrique lors de l'installation du kit.
S'assurer que les luminaires sont installés selon les spécifications du fabricant.
9. THE RETROFIT KIT IS ACCEPTED AS A COMPONENT OF A LUMINAIRE WHERE THE SUITABILITY OF THE COMBINATION SHALL BE DETERMINED BY AUTHORITIES HAVING JURISDICTION. PRODUCT MUST BE INSTALLED BY A QUALIFIED ELECTRICIAN IN ACCORDANCE WITH THE APPLICABLE AND APPROPRIATE ELECTRICAL CODES. THE INSTALLATION GUIDE DOES NOT SUPERSEDE LOCAL OR NATIONAL REGULATIONS FOR ELECTRICAL INSTALLATIONS.
LE NÉCESSAIRE DE MODERNISATION EST ACCEPTÉ À TITRE DE COMPOSANT D'UN LUMINAIRE LORSQUE LA PERTINENCE DE LA COMBINAISON DOIT ÊTRE DÉTERMINÉE PAR LA CSA OU PAR LES AUTORITÉS COMPÉTENTES. CE PRODUIT DOIT ÊTRE MIS EN PLACE PAR UN ELECTRICIEN QUALIFE CONFORMEMENT AUX CODES ELECTRIQUES APPROPRIES APPLICABLES. LE GUIDE D'INSTALLATION NE SUPPLANTE PAS LES REGLEMENTS LOCAUX OU NATIONAUX EN MATIERE D'INSTALLATIONS ELECTRIQUES.

INSTALLATION INSTRUCTIONS INSTRUCTIONS D'INSTALLATION

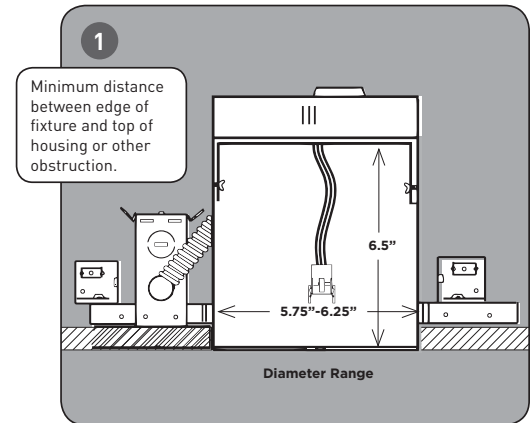

SAVE THESE INSTRUCTIONS FOR FUTURE REFERENCE

TO INSTALL:

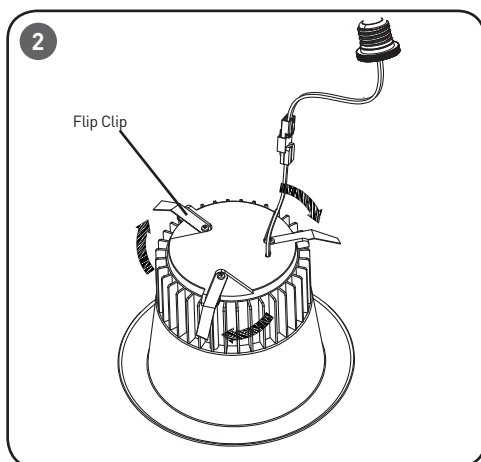

LIST OF SUPPLIED COMPONENTS

Kit contains the following parts:

- LRX downlight unit
- E26 pigtail
- GU24 pigtail
- 277V connector pigtail
- Installation sheet
- UL label (sticker)

RECESSED HOUSING COMPATIBILITY

- Compatibility of housings may be determined by measurement of the housing as detailed in the above drawing (Figure 1). To ensure compatibility, a test installation should be completed.

INSTALLATION

STEP 1:

Remove LR6™ Fixture from the packaging and rotate the "Flip Clips" clockwise until they are perpendicular to the cover. See Figure 2.

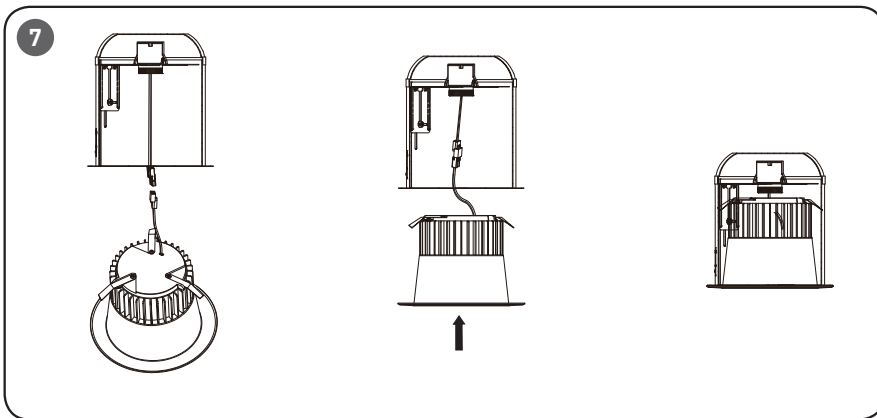
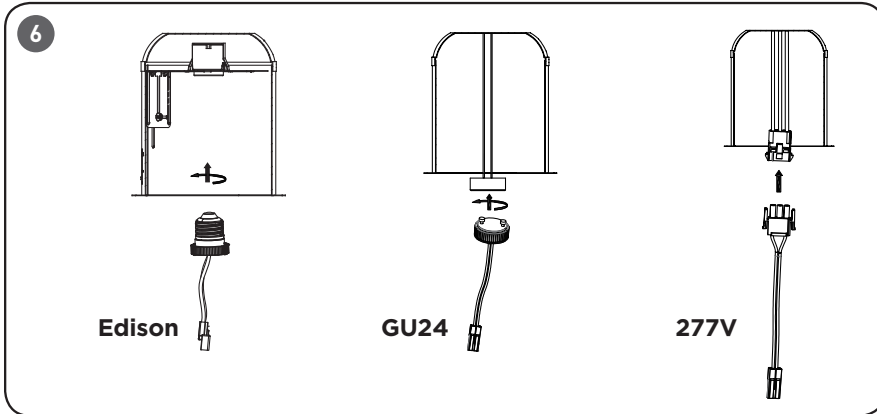
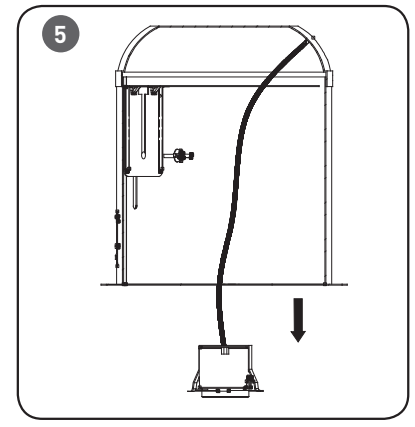
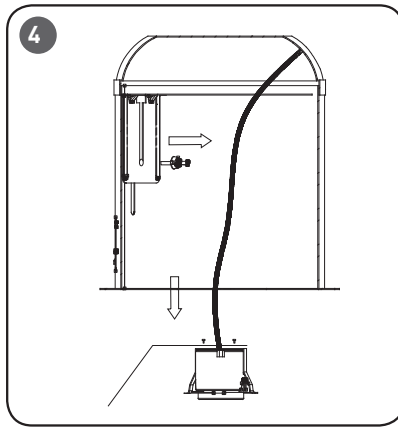
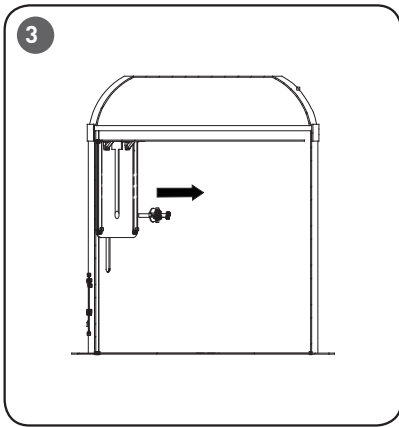

STEP 2:

Make sure the power is turned off at the source to the recessed housing(s) that you are installing the fixture(s) in. If installing into Cree Lighting housing, skip to STEP 7.

STEP 3:

Once power has been turned off, remove existing trim and CFL, or Incandescent, bulb revealing the existing socket.

STEP 4:

Locate the socket in your existing recessed housing and remove any screws that prevent the socket bracket from being removed. See **Figure 3**.

STEP 5:

Pull socket assembly, including the bracket, as low as possible given the existing wire length available. Remove any excess bracketry from socket. See **Figure 4**.

STEP 6:

Once you have removed the excess bracketry from the socket, you are now ready to install the LR6™ fixture. See **Figure 5**.

STEP 7:

For Edison Connection (on select models): Screw the adapter into the can's socket. See **Figure 6**.

REMOVAL OF LR6™ SERIES

NOTE: Make sure power to fixture is removed before attempting to disconnect LR6™ module from fixture.

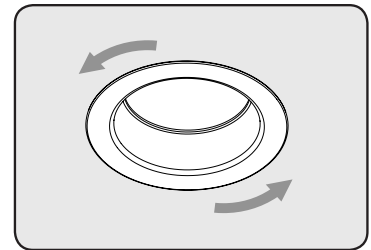

STEP 1:

To remove LR6™ module, grip firmly on the trim ring and rotate 1/4 turn counterclockwise to unlock clips from recessed can.

STEP 2:

Continue to turn counterclockwise as you pull downward on the LR6™. This will disengage the clips allowing the LR6™ to pull free.

STEP 3:

Detach LR6™ from recessed housing socket

NOTE: This device is not intended for use with emergency exit fixtures or emergency exit lights.

For GU24 Connections :

Rotate the adapter into the can's socket. See **Figure 6**.

For 277V Connections :

Pair insert the adapter into the can's socket. See **Figure 6**.

STEP 8:

Insert the connectors together. Slide LR6™ with clips, in ready position, up into the recessed housing until trim ring is flush with ceiling. Your LR6™ fixture should now be securely installed into the ceiling. Turn power on and enjoy. See **Figure 7**.