

Data sheet | Item number: 773-173

PUSH WIRE® connector for junction boxes; for solid and stranded conductors; max. 6 mm²; 3-conductor; transparent housing; red cover; Surrounding air temperature: max 60°C; 6,00 mm²; multicoloured

<https://www.wago.com/773-173>

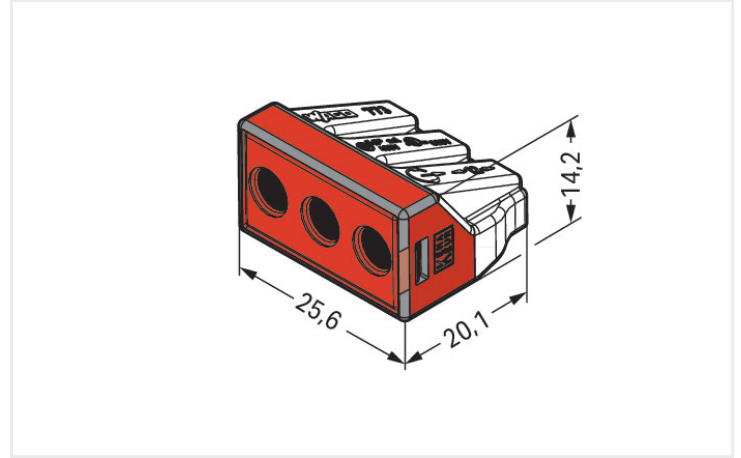
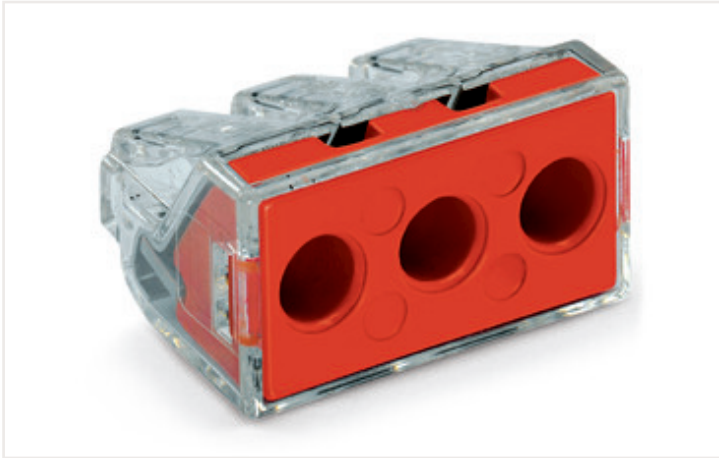

Dimensions in mm

Notes

Safety information 1

in grounded power lines

Electrical data

Ratings per IEC/EN

Ratings per	IEC/EN 60664-1
Nominal voltage (II/2)	400 V
Rated surge voltage (II/2)	4 kV
Rated current	41 A
Legend (ratings)	(II / 2) ≙ Overvoltage category II / Pollution degree 2

Connection data

Total number of connection points	3
Total number of potentials	1

Connection 1

Connection technology	PUSH WIRE®
Actuation type	Push-in
Connectable conductor materials	Copper Aluminum

Connection 1

Connectable conductor materials (note)

Terminating Aluminum Conductors

WAGO spring clamp terminal blocks are suitable for solid aluminum conductors up to 4 mm²/12 AWG if WAGO "Alu-Plus" Contact Paste [249-130](#) is used for termination.

"Alu-Plus" Contact Paste Advantages:

- Automatically destroys the oxide film during clamping.
- Prevents fresh oxidation at the clamping point.
- Prevents electrolytic corrosion between aluminum and copper conductors (in the same terminal block).
- Provides long-term protection against corrosion.

For spring clamp connections with PUSH WIRE® connection technology, **WAGO recommends that the aluminum conductor first be cleaned** and then immediately inserted into the clamping unit filled with "Alu-Plus" contact paste.

It is also possible to apply WAGO "Alu-Plus" **additionally** on the whole surface of the aluminum conductor before termination.

Please note that the nominal currents must be adapted to the reduced conductivity of the aluminum conductors::

2.5 mm² = 16 A

4 mm² = 22 A

Solid conductor	2.5 ... 6 mm ² / 14 ... 10 AWG
Stranded conductor	2.5 ... 6 mm ² / 14 ... 10 AWG
Strip length	12 ... 13 mm / 0.47 ... 0.51 inches
Wiring direction	Side-entry wiring

Physical data

Width	25.6 mm / 1.008 inches
Height	14.2 mm / 0.559 inches
Depth	20.1 mm / 0.791 inches

Material data

Note (material data)	Information on material data can be found here
Color	multicoloured
Cover color	red
Flammability class per UL94	V2
Fire load	0.115 MJ
Weight	5.8 g

Environmental requirements

Ambient temperature (operation)	+60 °C
Continuous operating temperature	105 °C

Commercial data

eCl@ss 10.0	27-14-11-04
eCl@ss 9.0	27-14-11-04
ETIM 8.0	EC000446
ETIM 7.0	EC000446
PU (SPU)	500 (50) Stück
Packaging type	Box
Country of origin VKOrg Germany	CN
GTIN	4050821215141
Customs tariff number VKOrg Germany	85369010000

Approvals and certificates

Country specific Approvals



Approval	Standard	Certificate name
CSA DEKRA Certification B.V.	C22.2	15411 (LR46759)
ENEC 15 UL International Germany GmbH	EN 60998	ENEC-01207

Ship Approvals



Approval	Standard	Certificate name
ABS American Bureau of Shipping	-	18-HG1755093-PDA

UL-Approvals



Approval	Standard	Certificate name
UL UL International Germany GmbH	UL 486C	E69654

Downloads

Environmental Product Compliance

Compliance Search

Environmental Product Compliance 773-173





Documentation

Additional Information

Technical Section	pdf 2142.18 KB	
-------------------	-------------------	---

Bid Text



773-173	19.02.2019	xml 3.24 KB	
773-173	17.05.2017	doc 25.00 KB	
ausschreiben.de 773-173			

CAD/CAE-Data

CAD data

2D/3D Models 773-173	
----------------------	---

CAE data

EPLAN Data Portal 773-173	
WSCAD Universe 773-173	
ZUKEN Portal 773-173	

1 Compatible products

1.1 Optional accessories

1.1.1 Mounting adapter

1.1.1.1 Mounting accessories

**Item no.: 773-332**

Mounting carrier; 773 Series - 2.5 mm² / 4 mm² / 6 mm²; for DIN-35 rail mounting / screw mounting; orange

1.1.2 Tool

1.1.2.1 "Alu-Plus" contact paste

**Item no.: 249-130**

Syringe; Contents: 20 ml Alu-Plus contact paste