

Description

UL 1598C Classified LED retrofit kits with linear modules, for any linear applications such as troffer, wraparound, strips, etc.

Features

- Driver + Module kits, no lamp socket needed
- Magnet on the back for easy installation
- UL 1598C Classified Retrofit Kits
- UL Class 2 Low Voltage System
- 3 Steps MacAdam Steps for Accurate Color
- Long life 50,000 hours
- 5 Years Warranty of Whole System
- Universal Input 120/277V
- 0-10V Dimming
- NSF 2 Complied with PC lens
- Aluminum backing for heatsink, independent to Fixtures
- True Multi Channel Operation
- Programmable with Multiple Light Levels
- Flicker-free, Meets IEEE 1798-2015

[*Emergency Driver Solution Option](#)

Content

(1) VPL50-2C, Field-Adjustable Multi Channel Constant Current Driver
 (1) VLM4813F/8XX Linear LED Module
 User Manual [versaLinear_kit_Installation_Guide_2021.10.7.pdf](#)



VersaLinear™
 Commercial Grade LED Linear Retrofit Kits

Specification Data

Kit Order Code	Application	Mode	Kit Model	System Lumen	System Wattage	System Efficacy	CRI	Module	Driver	Power Factor	THD
VEKM-L41F/830	1 lamp, 4ft 3000K	Low Wattage	D546-1M-304 F/830	1280	11.5	111	83	VLM4813F/830	VPL50-2C	>0.9	<20%
VEKM-L41F/835	1 lamp, 4ft 3500K	Low Wattage	D546-1M-304 F/835	1280	11.5	111	83	VLM4813F/835	VPL50-2C	>0.9	<20%
VEKM-L41F/840	1 lamp, 4ft 4000K	Low Wattage	D546-1M-304 F/840	1280	11.5	111	83	VLM4813F/840	VPL50-2C	>0.9	<20%
VEKM-L41F/850	1 lamp, 4ft 5000K	Low Wattage	D546-1M-304 F/850	1280	11.5	111	83	VLM4813F/850	VPL50-2C	>0.9	<20%
VEKM-L41F/830	1 lamp, 4ft 3000K	Normal Wattage	D546-1M-304 F/830	1550	14	111	83	VLM4813F/830	VPL50-2C	>0.9	<20%
VEKM-L41F/835	1 lamp, 4ft 3500K	Normal Wattage	D546-1M-304 F/835	1550	14	111	83	VLM4813F/835	VPL50-2C	>0.9	<20%
VEKM-L41F/840	1 lamp, 4ft 4000K	Normal Wattage	D546-1M-304 F/840	1550	14	111	83	VLM4813F/840	VPL50-2C	>0.9	<20%
VEKM-L41F/850	1 lamp, 4ft 5000K	Normal Wattage	D546-1M-304 F/850	1550	14	111	83	VLM4813F/850	VPL50-2C	>0.9	<20%
VEKM-L41F/830	1 lamp, 4ft 3000K	High Wattage	D546-1M-304 F/830	1850	18	103	83	VLM4813F/830	VPL50-2C	>0.9	<20%
VEKM-L41F/835	1 lamp, 4ft 3500K	High Wattage	D546-1M-304 F/835	1850	18	103	83	VLM4813F/835	VPL50-2C	>0.9	<20%
VEKM-L41F/840	1 lamp, 4ft 4000K	High Wattage	D546-1M-304 F/840	1850	18	103	83	VLM4813F/840	VPL50-2C	>0.9	<20%
VEKM-L41F/850	1 lamp, 4ft 5000K	High Wattage	D546-1M-304 F/850	1850	18	103	83	VLM4813F/850	VPL50-2C	>0.9	<20%

Module Dimensions

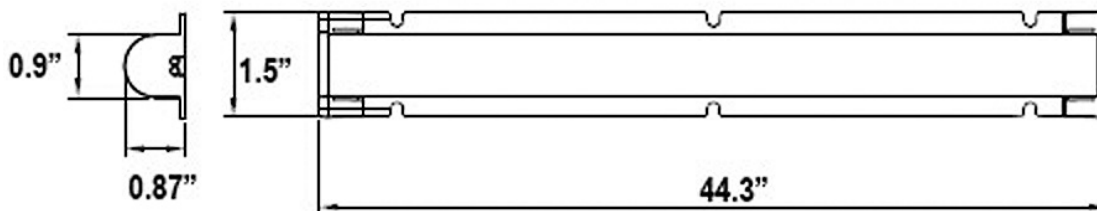

Driver Dimensions

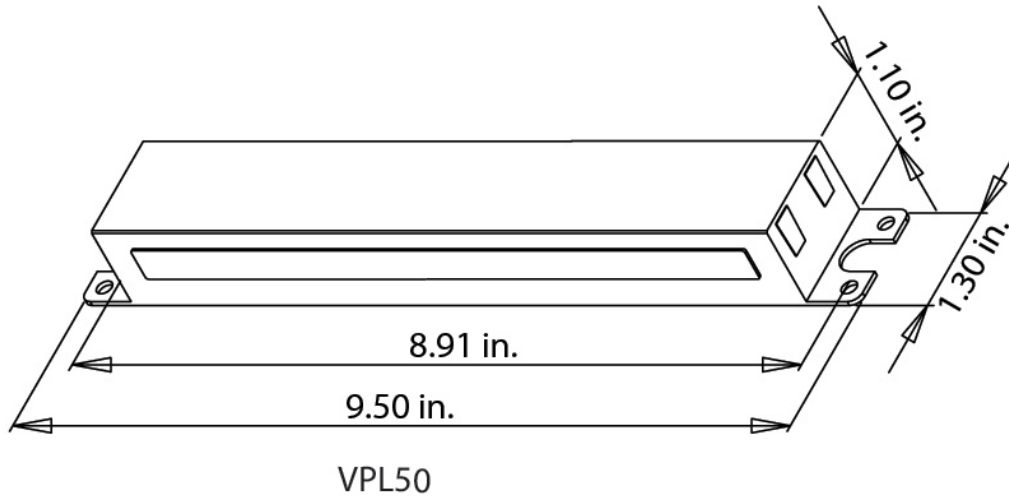

Wiring Diagram

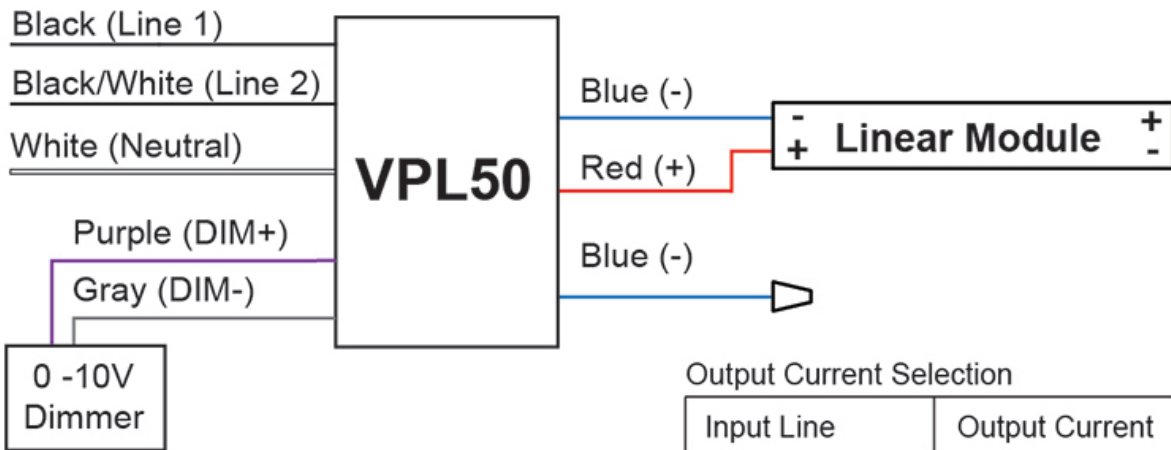

Output Current Selection

Input Line	Output Current
L1 (BLK)	300mA
L2 (BLK/WHT)	250mA
L1 + L2	360mA

Order Information

EXAMPLE: **VEKM42F/HO/840**

VEKM	4	2	F	/	HO	/	8	40
VersaLinear Linear Retrofit Module Kit	Module Length 4 - 4ft 3 - 3ft 2 - 2ft	Module Quantity 1 - 1 Module 2 - 2 Modules 3 - 3 Modules 4 - 4 Modules	Lens F - Frosted C - Clear (No Lens)	/	Output Mode Empty - Normal Output HO - High Output VHO - Very High Output	/	CRI 8 - CRI > 80	CCT 30 - 3000K 35 - 3500K 40 - 4000K 50 - 5000K

DLC Information



Order Code	Mode	DLC Product ID	DLC Product Model	DLC Product Version
VEKM-L41F/830	Low Wattage	N/A	N/A	N/A
VEKM-L41F/835	Low Wattage	N/A	N/A	N/A
VEKM-L41F/840	Low Wattage	N/A	N/A	N/A
VEKM-L41F/850	Low Wattage	N/A	N/A	N/A
VEKM-L41F/830	Normal Wattage	N/A	N/A	N/A
VEKM-L41F/835	Normal Wattage	N/A	N/A	N/A
VEKM-L41F/840	Normal Wattage	N/A	N/A	N/A
VEKM-L41F/850	Normal Wattage	N/A	N/A	N/A
VEKM-L41F/830	High Wattage	N/A	N/A	N/A
VEKM-L41F/835	High Wattage	N/A	N/A	N/A
VEKM-L41F/840	High Wattage	N/A	N/A	N/A
VEKM-L41F/850	High Wattage	N/A	N/A	N/A

Specification data is based on tests performed in a controlled environment and represents relative performance. Actual performance can vary depending on operating conditions. Application and performance data subject to change without notice. All specifications are nominal unless noted otherwise.