

The NXFC Series is a part of the NXF family of NEMA 4X and UL-EPH Classified emergency lighting solutions for extreme commercial and heavy industrial environments. The NXF family offers protection against humidity, dust, and water infiltration and is comprised of the [NXFX \(Exit Sign\)](#), [NXFC \(Exit Combo\)](#), [NXFE \(Emergency Lighting Unit\)](#), and [NXFR \(Remote Head\)](#). The reinforced polycarbonate enclosure with impact-resistant, UV-stable polycarbonate lens is suitable for vandal-prone areas and Wet Locations.

Model: _____ Date: _____
Accessories: _____
Job Name: _____ Type: _____

FEATURES

- NEMA 4X Certified
- UL-EPH Classified
- California Energy Commission (CEC) compliant
- IP66 Rated
- Provides 4.8W, 7.8W and 20.8W of remote capacity with 12W, 15W and 28W models respectively (with lamp heads); provides 11.4W, 14.4W and 27.4W of remote capacity with 12W, 15W and 28W models respectively (without lamp heads); compatible with [NXFR remote heads](#)
- Touchless, magnetically operated test switch
- Easy snap-out, field-selectable chevrons
- Up to 52' on-center spacing

SPECIFICATIONS

Illumination: Long-life, high-intensity, green or red LEDs.
Two 3.3W LED MR16 style lamp heads

Housing: NEMA 4X rated polycarbonate enclosure, polycarbonate lens and stainless steel hardware

Electrical Input: 120/277VAC Dual primary, 60Hz

Battery: Maintenance-free sealed lead calcium or NiCad battery

Operating Temp: 12W and 15W Models: 0°C to 50°C (32°F to 122°F)
28W Models: 10°C to 40°C (50°F to 104°F)
Cold Location Option: -20°C to 50°C (-4°F to 122°F)

Run Time: 90 Minute emergency run time, 24 hour recharge time

Legend: Fully illuminated 6" characters with 3/4" stroke

Mounting: Back, end or top mount

Finishes: Black or White

Certifications: UL 924 Listed for Wet Locations
Meets NFPA 101 Life Safety Code, NEC, OSHA
ANSI/UL Classified for use in food service operations
California Energy Commission (CEC) Title 20 Compliant
NEMA 4X and IP66 Rated

Warranty: Any component that fails due to a manufacturing defect is guaranteed for five years with a separate two year prorated warranty for sealed lead calcium batteries and five year prorated warranty for NiCad batteries. The warranty does not cover physical damage, abuse or instances of uncontrollable natural forces. See the full Exitronix warranty document for detailed information.

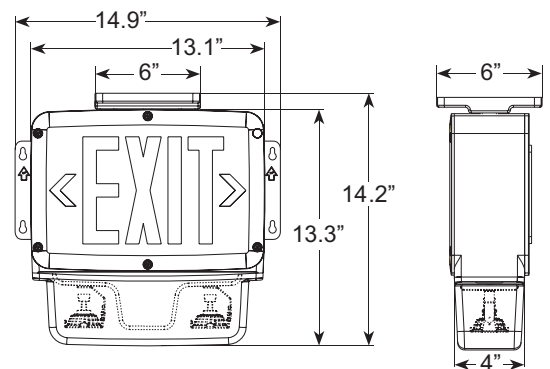

ORDERING INFORMATION Example: NXFC-1-G-6-15-BL-G2

Series	Style	Legend Color	Voltage	Wattage ³	Finish	Options (Factory Installed)
NXFC	1 ¹ = Single-face	G = Green Legend	6 = 6 Volt	12 ⁴ = 12 Watts	BL = Black	CL ⁶ = Cold Location -20°C to 50°C (-4°F to 122°F)
	2 ² = Double-face	R = Red Legend	12 = Volt	15 ⁴ = 15 Watts	WH = White	G2 = Self-test/Self-diagnostics
Notes				28 ⁵ = 28 Watts	NH = No Lamp Heads	
¹ Available only with 15W and 28W						TRH = Tamper-resistant Hardware
² Available only with 12W						
³ Compatible with NXFR single or double remote lamp heads						
⁴ NiCad battery only						
⁵ Sealed lead calcium battery only						
⁶ Available only with 12W and 15W						

CONSTRUCTION

The NXFC Series enclosure is made of UV-stable, reinforced polycarbonate coupled with a polycarbonate lens, corrosion-resistant hardware, and a molded gasket to provide protection for the equipment inside against ingress of solid foreign objects (dust) and water.

Stencil letters are 6" high with 3/4" stroke.

ILLUMINATION

Illumination of the NXFC exit face is achieved with high-output, long-lasting red or green LEDs exceeding UL 924 requirements for brightness and uniformity. An exclusive color-matched diffuser eliminates hot spots and striations, providing optimal light output. Emergency lights feature three LEDs x 1.1W per LED for 3.3W per lamp head that deliver 219 lumens in each MR16 style lamp head to provide optimal center-to-center spacing. The lamp assembly is fully enclosed within a high-abuse polycarbonate lens with an option for tamper-resistant hardware. Compatible with **NXFR** single or double remote lamp heads.

ELECTRICAL

Input

Dual-voltage input 120/277VAC @ 60Hz.

Battery/Charger/Indicator

Maintenance-free 6V/12V long-life, rechargeable nickel-cadmium batteries for 12W and 15W models. Maintenance-free 6V/12V long-life, rechargeable sealed lead-acid batteries for 28W models. Fully automatic solid-state, two rate charger initiates battery charging to recharge a discharged battery within 24 hours. The internal solid-state transfer switch automatically connects the internal battery to power the LED board for a minimum of 90 minutes of illumination during the loss of utility power. A bi-color LED indicator light alerts occupant on battery condition (Green-normal, Red-check battery).

Test Button

The NXFC uses a touchless magnetic test switch (non-AC models only) along with an LED light indicator for code compliance testing.

INSTALLATION

Universal knockout pattern on back provided with gasket for watertight seal for back mount. Polycarbonate mounting canopy included for ceiling or end mount.

OPTIONS

Cold Location Rated (Option: CL)

The NXFC offers a Cold Location option and extends the temperature range to -20°C to 50°C (-4°F to 122°F). This option is ideal for colder climates or freezer/cold room applications.

No Lamp Heads (Option: NH)

The NXFC offers a no emergency lamp head option to be used as an exit only with remote capability. Compatible with **NXFR** single or double remote lamp heads.

Tamper-Resistant Hardware (Option: TRH)

Tamper-resistant hardware adds an additional layer of protection to the unit, preventing unwanted access to the interior of the unit or removal of the lens.

Guardian Self-Test/Self-Diagnostics (Option: G2)

The Guardian circuit continuously monitors the operating condition of the AC power, battery supply voltage, emergency lamp continuity and charging circuit.

The purpose of this option is to provide visual signaling in response to a fault at the EXIT sign battery and/or battery charger. If a failure is detected, visual status will occur immediately via the CHARGER LED and/or the BATTERY FAULT LED. The LED will stay illuminated until the fault is corrected.

The Guardian circuit also monitors the transfer circuit as well as performing automatic code-compliant testing. The Guardian circuit will perform a 30 second discharge and self-test every 30 days. A 60 minute discharge and self-test is performed every 6 months, and a 90 minute discharge and self-test is performed every 12 months.

Red LED	Unit Fault	Corrective Action
Steady	Battery Disconnected	Check Battery Connection
1 Blink	Electronics Failure	Check Battery Then Consult Factory
2 Blinks	Battery Failure	Check Battery Then Consult Factory
3 Blinks	N/A	N/A
4 Blinks	Emergency Lamp	Check Lamp Connections Then Consult Factory
5 Blinks	Remote Lamp	Check Remote Lamp Connections Then Consult Factory

NEMA 4X Rated (Standard)

NEMA 4X rated fixtures are designed for outdoor applications. NEMA 4X rating ensures that the fixtures will withstand contact with falling dirt, moderate or jet-driven water, ice and corrosion. NEMA 4X fixtures are designed to perform in Hose-Down applications.

IP66 Rated (Standard)

IP66 rating ensures that the product can be installed in outdoor applications where significant water or dust may come in contact with the fixture. IP66 rated fixtures are fixtures designed to perform in Hose-Down applications.

UL-EPH Classified (Standard)

UL-EPH classification ensures that the equipment has been evaluated, tested, and classified to Environmental and Public Health Standards, and certified by ANSI/UL as complying with international commercial food equipment hygiene codes and requirements and that the product can be installed in food processing applications.

CONFORMANCE TO CODES & STANDARDS

The NXFC Series is UL Listed for Wet Locations and meets or exceeds the following: NEC requirements and NFPA 101.

SAMPLE PHOTOMETRICS - 3' PATH OF EGRESS

Using multiple NXFC units mounted at a typical 7.5' height delivers 52' on-center spacing with a 3' wide path of egress using 80/50/20 reflectances.

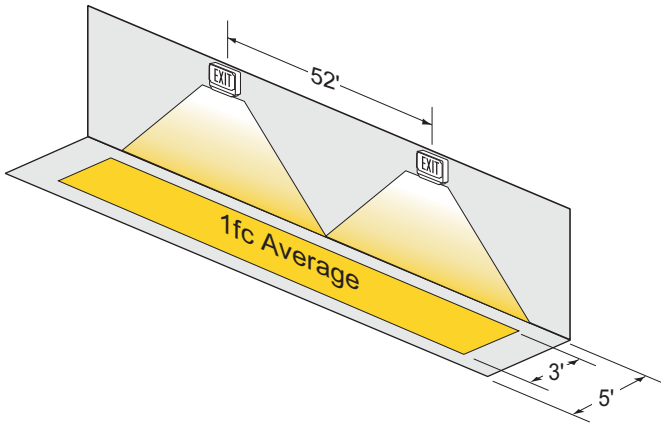

SAMPLE PHOTOMETRICS - 6' PATH OF EGRESS

Using multiple NXFC units mounted at a typical 7.5' height delivers 48' on-center spacing with a 6' wide path of egress using 80/50/20 reflectances.

