

LED 2X4 Multi Watt Multi CCT Back Lit Panel

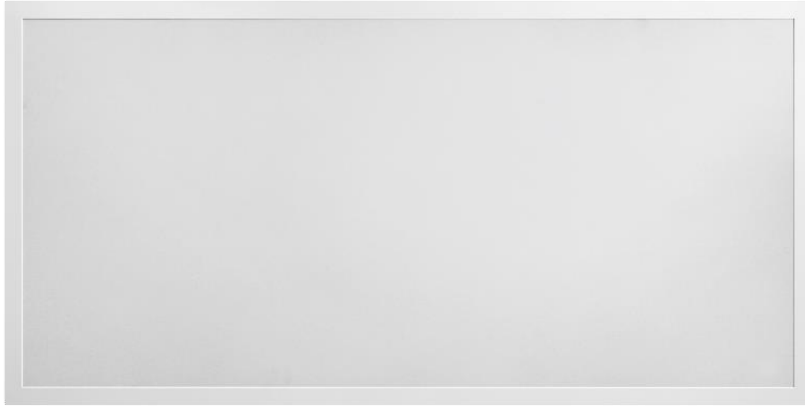

2x4

29W, 34W, 39W and 49W

FEATURES

- Default Wattage is the highest wattage
 - 2x4 – 49W
- Default CCT: 5,000K
- IP20 rating – dry location
- Glare-free / flicker-free lighting
- 100,000 hours lifetime

SUITABLE APPLICATIONS

- Warehouses
- Schools
- Factories
- Offices
- Supermarkets
- Logistic Centers
- Exhibition Halls

CONSTRUCTION:

Steel and Aluminum frame. PMMA lens material to prevent panel from yellowing. The entire fixture functions as a heat sink to keep the LEDs cooler to prolong the life of the light.

OPTICAL SYSTEM:

Lumiled 2835 LED chips. 120° beam angle.

WARRANTY:

5-year limited warranty. Actual performance may differ as a result of end-user environment and application.

ELECTRICAL:

120-277V input standard.
-20°C to 50°C, -4°F to 122°F

INSTALLATION & MOUNTING:

Fits standard T-bar and narrow grid drop ceilings.
Surface mount kit, recessed kit or hanging kit.

CONTROLS & DIMMING:

0-10V dimming comes standard. Suitable for use with LED dimmers.



MODEL NUMBER – 3,500K, 4,000K and 5,000K	SIZE	WATTAGE	LUMENS	EFFICACY	CRI	POWER FACTOR	THD	REPLACES
LOC-24BLPL-MW(29/34/39/49)MCCT(35/40/50)	2x4	29W	3,300.2LM	113.8LM/W	80	0.9	20%	200W HID
LOC-24BLPL-MW(29/34/39/49)MCCT(35/40/50)	2x4	34W	3,869.2LM	113.8LM/W				200W HID
LOC-24BLPL-MW(29/34/39/49)MCCT(35/40/50)	2x4	39W	4,438.2LM	113.8LM/W				200W HID
LOC-24BLPL-MW(29/34/39/49)MCCT(35/40/50)	2x4	49W	5,576.2LM	113.8LM/W				200W HID

Series	Size	2x4 Wattage	Color Temperature	Optional
LOC-BLPL	24 = 2x4	29W 34W 39W 49W	3500K 4000K 5000K	EM = emergency backup MS = motion sensor

MEASUREMENTS

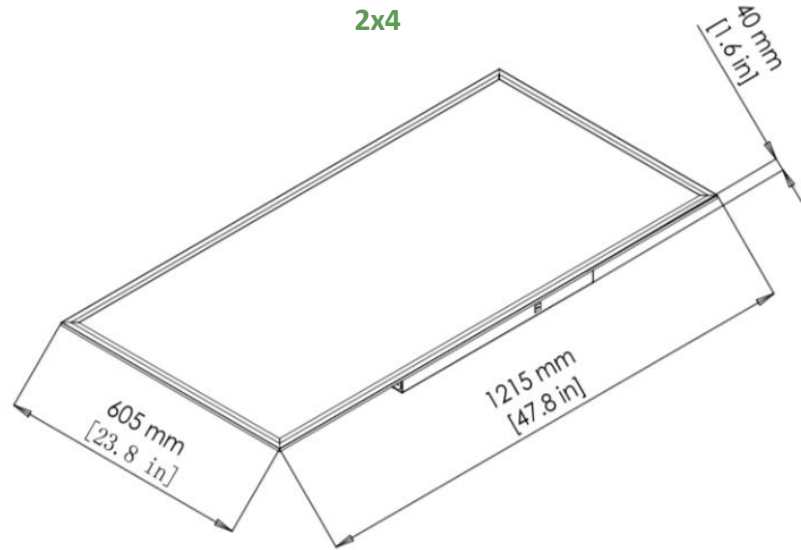

MODEL	QUANTITY	WEIGHT	UPC CODE
LOC-24BLPL-MW(29/34/39/49)(MCCT(35/40/50)	1	10.3 lbs	00810050940429

PHOTOMETRIC DATA

2x4 29W

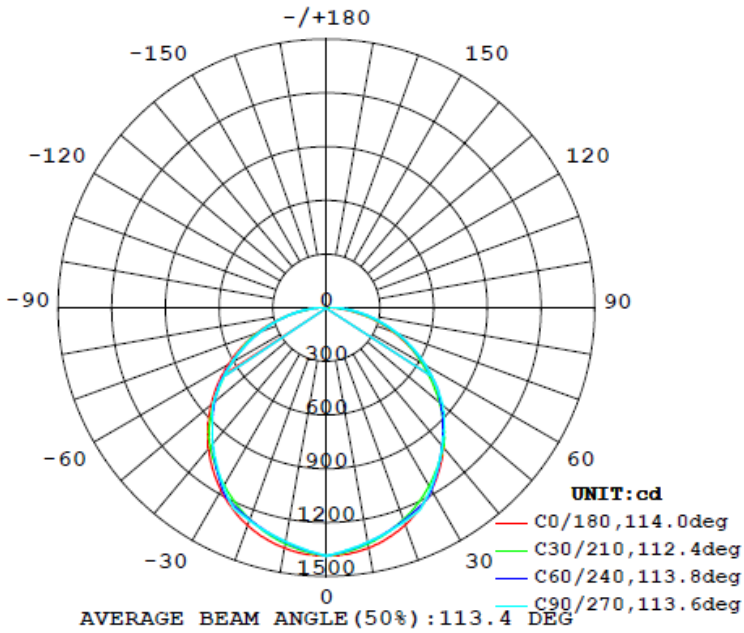

Flux out: 2911 lm

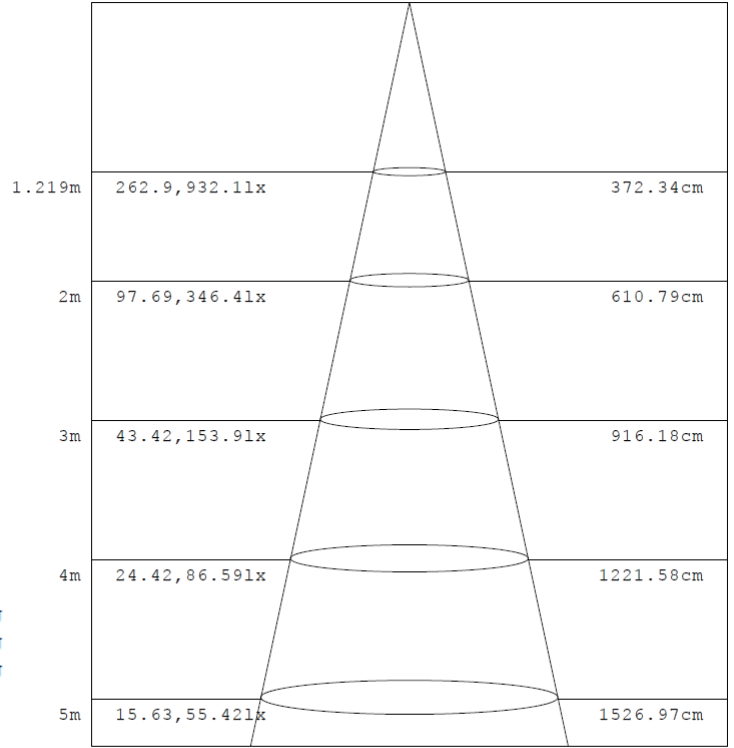

Note: The Curves indicate the illuminated area and the average illumination when the luminaire is at different distance.

2x4 34W

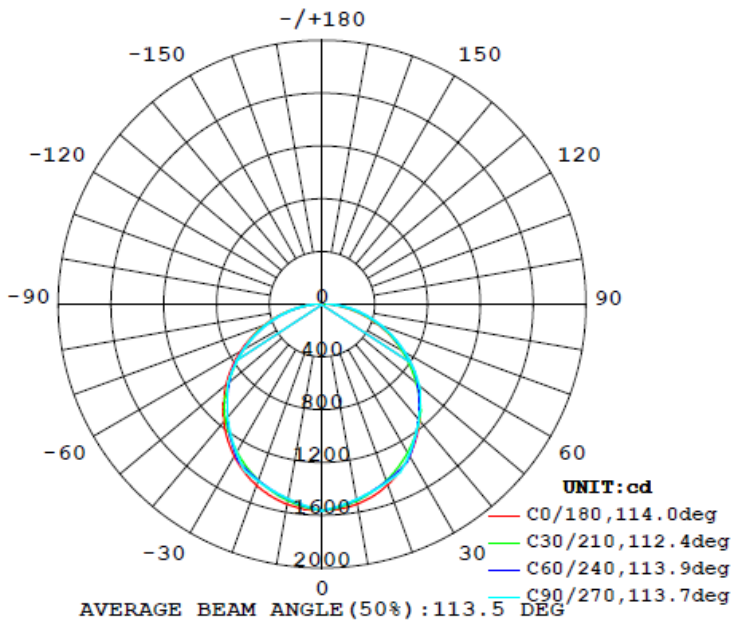

Flux out: 3288 lm

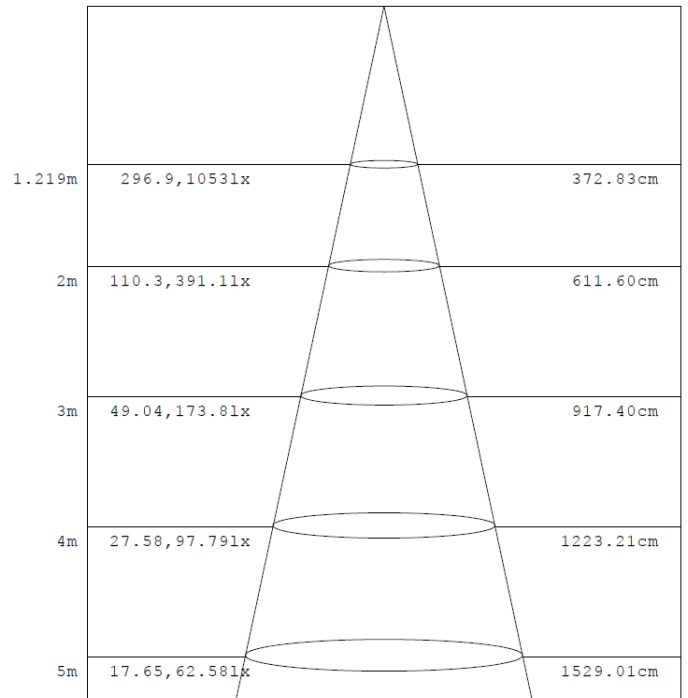

Note: The Curves indicate the illuminated area and the average illumination when the luminaire is at different distance.

2x4 39W

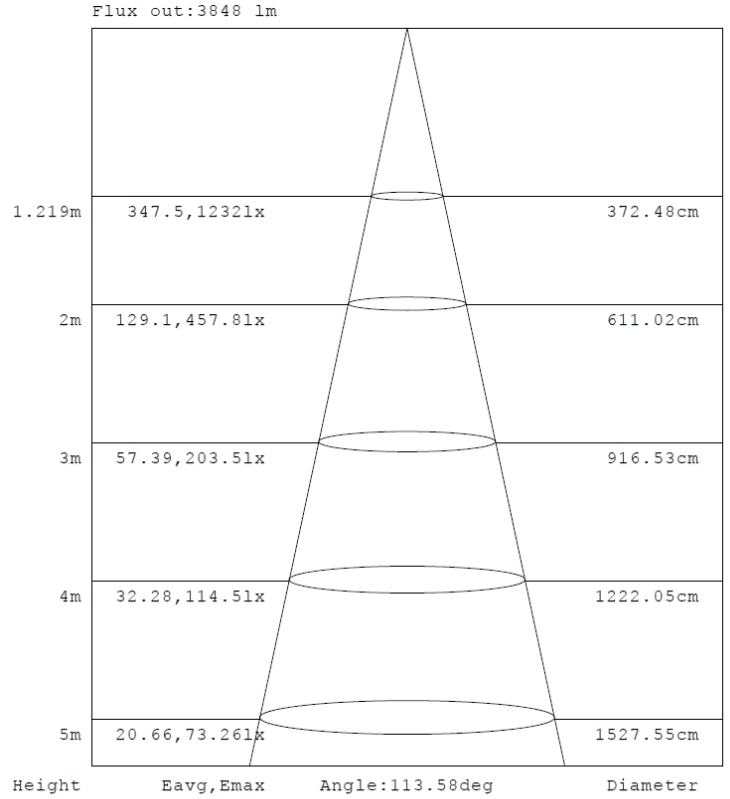
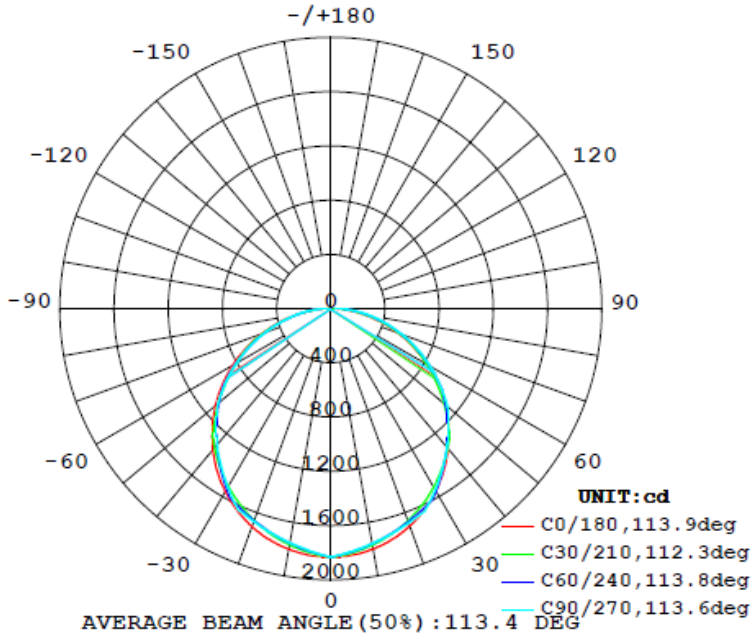

Note: The Curves indicate the illuminated area and the average illumination when the luminaire is at different distance.

2x4 49W

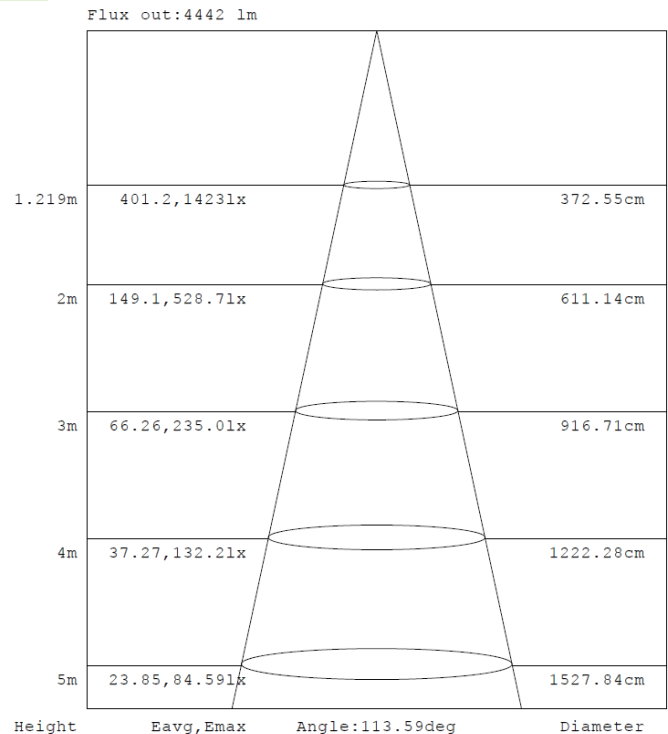
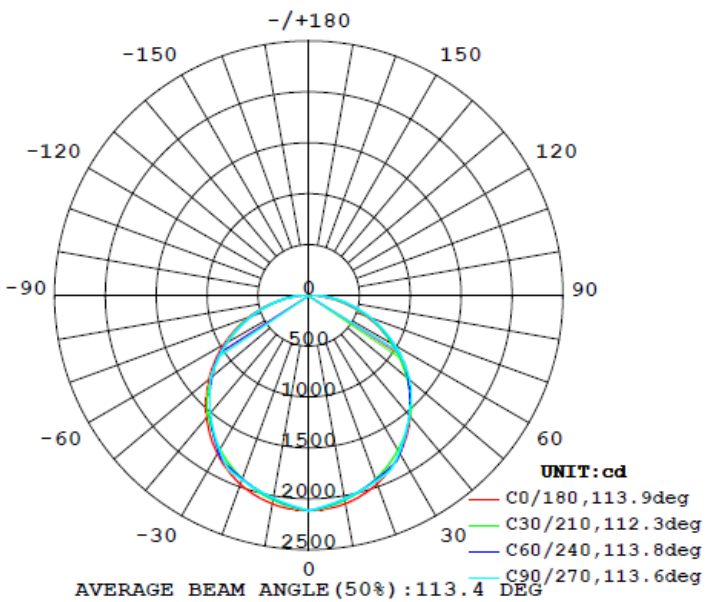

Note: The Curves indicate the illuminated area and the average illumination when the luminaire is at different distance.

MOUNTING OPTIONS

Surface Mount

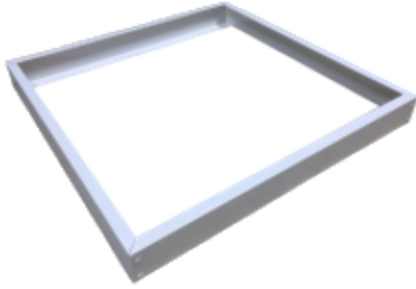

Recessed Mount



Hanging Kit



OPTIONAL ACCESSORIES



Emergency Driver



Mounting T-Bar Kit for
Emergency Driver



BPLED-EM-Bracket

