

LED Parking Garage Light Installation Instruction

Cautions:

1. Can not use the electric generator to test the LED lamp.
2. Please abide by related country, regional and local law and regulations when install this fixture.
3. Please turn off the power before installation or maintenance.
4. Proper earth grounding is required to ensure safety.

Notice:

1. To avoid possibility of electrical shock or fire, the installation personnel must have professional electric knowledge.
2. Please wear gloves to avoid injury before installation.
3. If any smoke or spark of the wire happened, please turn off the power immediately and notify relevant personnel.

Attention:

1. Please check if there is any damage during shipping. If so, please contact manufacturer timely.
2. Please read the installation instruction carefully to check whether all the accessories are complete. After confirmation, then install the fixture according to installation steps.

Wiring Diagram:

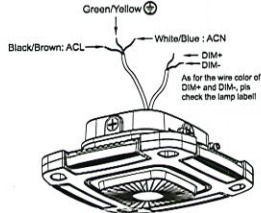

Installation Method I :

1. Disassemble the driver box cover by loosen the two screws on the driver box; Figure 1-1
2. Loosen the 3/4 plug on the driver box cover by screwdriver; Figure 1-2
3. Fix the driver box cover on the 3/4 tube; Figure 1-3
4. Insert the mounting hole of radiator horizontally to the shaft of driver cover; Figure 1-4
5. Connect ground/L/N wire inside driver rear cover; Set parameters if equipped with a microwave motion sensor. Take waterproof measures after wiring. Figure 1-5
6. Close the lamp body. Figure 1-6
7. Lock the two cap screws. Figure 1-7
8. Manually rotate the surrounding lighting modules to adjust the angle. Lock screws on the lighting modules. Installation completed. Figure 1-8

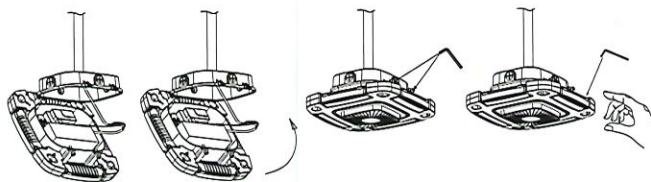
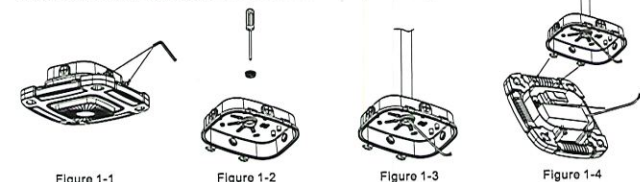

Figure 1-5

Figure 1-6

Figure 1-7

Figure 1-8

Installation Method II :

1. Disassemble the driver box cover by loosen the two screws on the driver box; Figure 2-1
2. Loosen the 3/4 plug on the driver box cover by screwdriver; Figure 2-2
3. Drill the holes on the ceiling accordingly to fit the plate; Figure 2-3
4. Fix the driver box cover on the ceiling; Figure 2-4
5. Insert the mounting hole of radiator horizontally on the shaft of driver cover; Figure 2-5
6. Connect ground/L/N wire inside driver rear cover; Set parameters if equipped with a microwave motion sensor. Take waterproof measures after wiring. Figure 2-6
7. Close the lamp body. Figure 2-7
8. Lock the two cap screws. Figure 2-8
9. Manually rotate the surrounding lighting modules to adjust the angle. Lock screws on the lighting modules. Installation completed. Figure 2-9

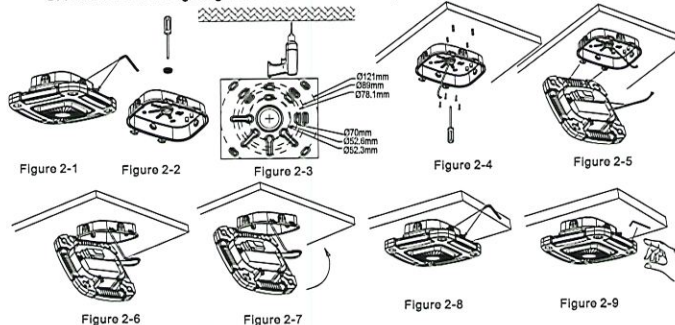

Figure 2-1

Figure 2-2

Figure 2-3

Figure 2-4

Figure 2-5

Figure 2-6

Figure 2-7

Figure 2-8

Figure 2-9

Installation Method III :

1. Disassemble the driver box cover by loosen the two screws on the driver box; Figure 3-1
2. Loosen the 3/4 plug on the driver box cover by screwdriver; Figure 3-2
3. Drill holes on the ceiling; Figure 3-3
4. Fix the driver box cover on the ceiling; Figure 3-4
5. Fix the lower bracket on the driver box cover; Figure 3-5
6. Align with the holes of upper and lower bracket; tighten with screws; Figure 3-6
7. Insert the mounting hole of radiator horizontally on the shaft of driver cover; Figure 3-7
8. Use M20 waterproof connector when connecting AC wire or dimming wire, take relevant waterproof measures at both sides of inlet. Figure 3-8
9. Connect ground/L/N wire inside driver rear cover; Set parameters if equipped with a microwave motion sensor. Take waterproof measures after wiring. Figure 3-9
10. Close the lamp body. Figure 3-10
11. Lock the two cap screws. Figure 3-11
12. Manually adjust the height of the lamp and rotate the surrounding lighting modules to adjust the angle. Lock screws on the lighting modules. Installation completed. Figure 3-12

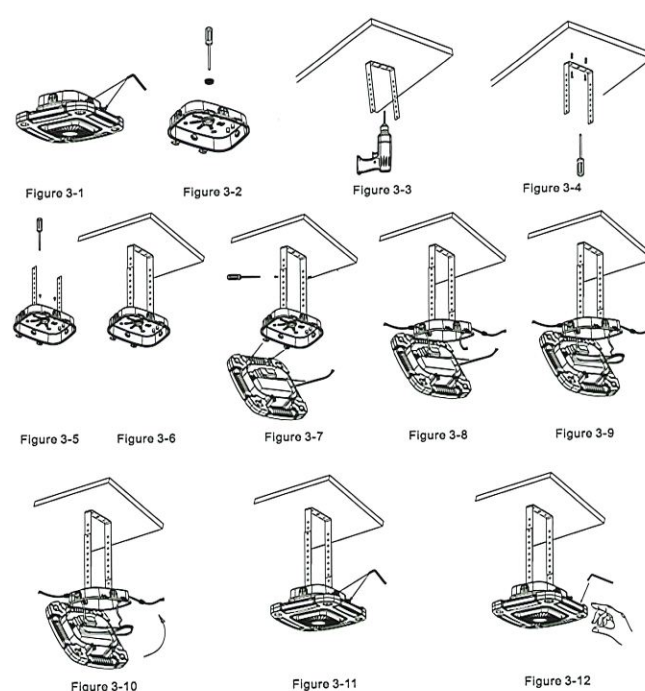

Figure 3-1

Figure 3-2

Figure 3-3

Figure 3-4

Figure 3-5

Figure 3-6

Figure 3-7

Figure 3-8

Figure 3-9

Figure 3-10

Figure 3-11

Figure 3-12

Installation Method IV :

1. Loosen two screws on the driver and remove driver rear cover Figure 4-1
2. Loosen the plug of wire hole on the driver rear cover Figure 4-2
3. Screw 4 studs of the hanging wire into screw hole on the driver rear cover Figure 4-3
4. Drill a hole on the ceiling; Insert and lock hook-type expansion screws; Hang the assembled driver rear cover on the hook Figure 4-4
5. Insert the lamp body mounting hole horizontally into the driver rear cover Figure 4-5
6. Take waterproof measures on entrance of both sides when using the M20 waterproof connector to connect AC wire or dimming wire Figure 4-6
7. Connect ground/L/N wire inside driver rear cover; Set parameters if equipped with a microwave motion sensor. Take waterproof measures after wiring. Figure 4-7
8. Close the lamp body. Figure 4-8
9. Lock the two cap screws. Figure 4-9
10. Manually adjust the height of the lamp and rotate the surrounding lighting modules to adjust the angle. Lock screws on the lighting modules. Installation completed. Figure 4-10



Figure 4-1



Figure 4-2



Figure 4-3



Figure 4-4



Figure 4-5



Figure 4-6

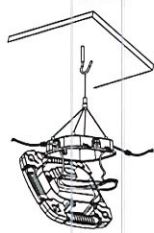

Figure 4-7

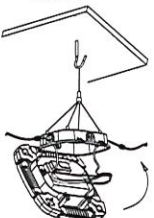

Figure 4-8

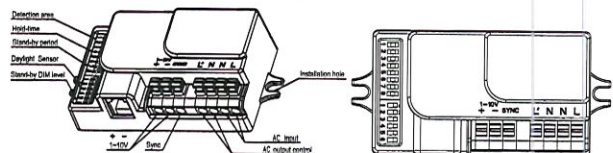

Figure 4-9



Figure 4-10

Structure of motion sensor



Settings:

By selecting the combination on the DIP switch, sensor data can be precisely set for each specific application.

	1	2
100%	ON	ON
75%	ON	-
50%	-	ON
25%	-	-

Detection area

Detection area can be reduced by selecting the combination on the DIP switches to fit precisely each application .

	3	4	5
5S	ON	ON	ON
30S	ON	-	ON
1min	-	ON	ON
5min	ON	-	-
15min	-	ON	-
30min	-	-	ON

Hold time

Refers to the time period the lamp remains at 100% illumination after no motion detected.

	6	7	8
0s	ON	ON	ON
1min	ON	-	ON
3min	-	ON	ON
5min	ON	-	-
10min	-	ON	-
30min	-	-	ON
∞	-	-	-

Stand-by level

Refers to the time period the lamp remains at a low light level before it completely switches off in the long absence of people. When set to Disable mode, the low light is maintained until motion is detected.

	1	2
10%	ON	ON
20%	ON	-
30%	-	ON
50%	-	-

Stand-by dim level

The low light level you would like to have after the hold time in the long absence of people.

	3	4	5	6
5Lux	ON	ON	ON	ON
10Lux	-	ON	ON	ON
30Lux	ON	-	ON	ON
50Lux	-	-	ON	ON
100Lux	ON	ON	-	ON
150Lux	ON	ON	ON	-
Disable	-	-	-	-

Daylight sensor

The sensor can be set to only allow the lamp to illuminate below a defined ambient brightness threshold.

When set to Disable mode, the daylight sensor will switch on the lamp when motion is detected regardless of ambient light level.

100lux, 100lux,50lux: twilight operation, 10lux, 5lux: darkness operation only. Note that daylight sensor is active only when lamp totally switches off.

Warning / Avertissement

MIN 75°C SUPPLY CONDUCTOR
THIS PRODUCT MUST BE INSTALLED IN ACCORDANCE WITH THE APPLICABLE INSTALLATION CODE BY A PERSON FAMILIAR WITH THE CONSTRUCTION AND OPERATION OF THE PRODUCT AND THE HAZARDS INVOLVED.

LES FILS D'ALIMENTATION 75°C MIN
CE PRODUIT DOIT ÊTRE INSTALLÉ SELON LE CODE D'INSTALLATION PERTINENT, PAR UNE PERSONNE QUI CONNAÎT BIEN LE PRODUIT ET SON FONCTIONNEMENT AINSI QUE LES RISQUES INHÉRENTS.