



Project:	Type:
Prepared By:	Date:

Driver Info		LED Info	
Type	Constant Current	Watts	55W
120V	470	Color Temp	Field Adjustable
208V	N/A	Color Accuracy	N/A
240V	N/A	L70 Lifespan	50,000 Hours
277V	210	Lumens	5,080
Input Watts	55W	Efficacy	92.4 lm/W

Technical Specifications

Other

Product Type:

Commercial Downlight Direct Mount

Warranty:

RAB warrants that our LED products will be free from defects in materials and workmanship for a period of five (5) years from the date of delivery to the end user, including coverage of light output, color stability, driver performance and fixture finish. RAB's warranty is subject to all terms and conditions found at rablighting.com/warranty.

Buy American Act Compliance:

RAB values USA manufacturing! Upon request, RAB may be able to manufacture this product to be compliant with the Buy American Act (BAA). Please contact customer service to request a quote for the product to be made BAA compliant.

Performance

Typical Lumen Output:

5000

Efficacy:

91 lm/W

Color Accuracy:

90 CRI

Color Temperature:

3000K | 3500K | 4000K | 5000K

Lifespan:

50,000-Hour LED lifespan based on IES LM-80 results and TM-21 calculations

Electrical

THD:

≤20%

Power Factor:

≥0.9

Dimmable:

Driver includes dimming control for 0-10V dimming systems. Requires separate 0-10V DC dimming circuit. Dims down to 10%.

Input Voltage:

120-277V

Operating Frequency:

50/60Hz

Operating Temperature:

-30°C - 40°C

Technical Specifications (continued)

Construction

Size:

8"

Shape:

Round

Housing Material:

Metal

Finish:

White

Trim Style:

Smooth Trim

Air Tight:

Housing certified Air Tight as per ASTM E283

Compliance**Safety Listing:**

UL Listed, UL Classified

Environment:

Wet

T24 JA8 Compliant:

Complies with Title 24 Appendix JA8

Lawful for Sale in California:

Yes

RoHS:

Mercury and UV free. RoHS-compliant components.

FCC:

Complies with Part 15 of the FCC Rules

Model Number:

DLC0052(C8R559FAUNVW)

Dimensions

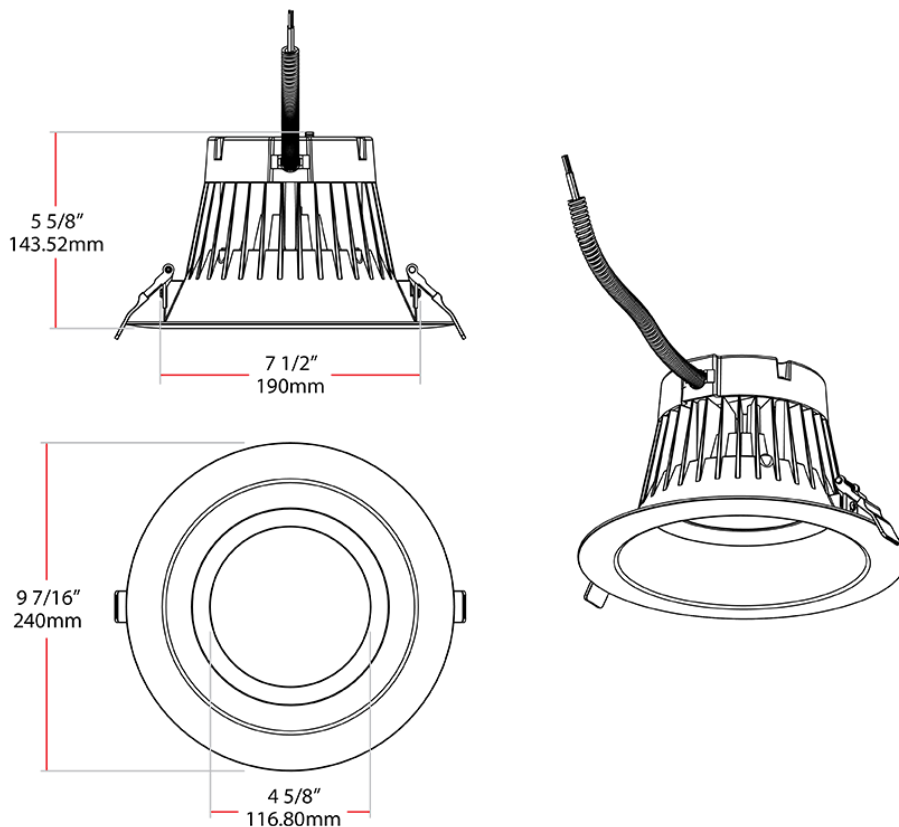

Ordering Matrix

Family	Size	Shape	Wattage	CRI/Color Temp	Voltage	Finish
C	8	R	55	9FA	UNV	W
	6 = 6" 8 = 8"	R = Round	11 = 11W 18 = 18W 22 = 22W 33 = 33W 55 = 55W	9FA = 90 CRI, Field Adjustable	UNV = 120-277V	W = White