

Project:	Type:
Prepared By:	Date:

Driver Info		LED Info	
Type	Constant Current	Watts	9W
120V	N/A	Color Temp	Field Adjustable
208V	N/A	Color Accuracy	90 CRI
240V	N/A	L70 Lifespan	50,000 Hours
277V	N/A	Lumens	679
Input Watts	9W	Efficacy	75.4 lm/W

Technical Specifications

Other

Product Type:

Recessed Direct Mount

LEDs:

Back-lit LED array provides a uniform source with high efficiency and no pixilation

Warranty:

RAB warrants that our LED products will be free from defects in materials and workmanship for a period of five (5) years from the date of delivery to the end user, including coverage of light output, color stability, driver performance and fixture finish. RAB's warranty is subject to all terms and conditions found at rablighting.com/warranty.

Equivalency :

Equivalent to 60W Incandescent

Buy American Act Compliance:

RAB values USA manufacturing! Upon request, RAB may be able to manufacture this product to be compliant with the Buy American Act (BAA). Please contact customer service to request a quote for the product to be made BAA compliant.

Performance

Lumens (Nominal):

600

Efficacy:

66.7 lm/W

Color Accuracy:

90 CRI

Color Temperature:

2700K | 3000K | 3500K | 4000K | 5000K

Lifespan:

50,000-Hour LED lifespan based on IES LM-80 results and TM-21 calculations

Electrical

Power Factor:

≥0.9

Dimmable:

TRIAC and ELV (at 120V only).

Input Voltage:

120V

Operating Frequency:

60Hz

Technical Specifications (continued)

Electrical

Operating Temperature:

-30°C - 40°C

Construction

Size:

4"

Shape:

Round

Finish:

White

Trim Style:

Smooth Trim

Lens:

Regressed lens
Impact-resistant polycarbonate
Convex form and lamp-like appearance
Diffuse for even illumination

Air Tight:

Housing certified Air Tight as per ASTM E283

Electrical Characteristics

THD:

<25%

Compliance

Safety Listing:

UL Listed

Environment:

Wet

IC Rated:

Suitable for direct contact with insulation

ENERGY STAR V2.2:

This product is ENERGY STAR® Version 2.2 Certified.

Energy Star ID:

2369050

T24 JA8 Compliant:

Complies with Title 24 Appendix JA8

RoHS:

Mercury and UV free. RoHS-compliant components.

FCC:

Complies with Part 15 of the FCC Rules

Model Number:

DLW0057(WFRD4R99FA120WS)

Dimensions

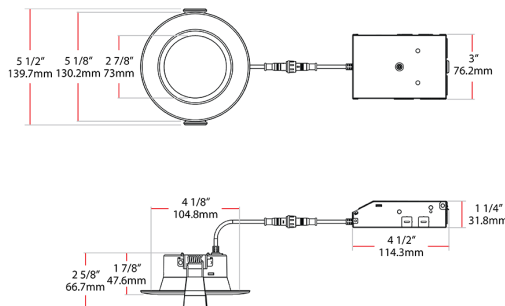

Features

- 5 color temperatures in 1 SKU (2700K, 3000K, 3500K, 4000K, 5000K)
- Back-lit deep regress remote driver downlight
- Available in a smooth trim option
- No recessed housing or J-box required
- New construction or retrofit applications
- UL wet location rated
- Smooth diffused uniform light distribution
- Dimmable down to 5% on compatible dimmers
- Spring loaded retention clips
- Robust, die cast aluminum construction
- IC and airtight rated
- 5-Year, No-Compromise Warranty

Ordering Matrix

Family	Size	Shape	Wattage	CRI/Color Temp	Voltage	Finish	Trim
WFRD	4	R	9	9FA	120	W	S
	4 = 4" 6 = 6"	R = Round	9 = 9W 13 = 13W	9FA = 90 CRI, Field Adjustable	120 = 120V	W = White	S = Smooth