

| | |
|----------|------|
| Project | |
| Schedule | Date |
| Notes | |

DESCRIPTION

LED Filament Lamps replicate the traditional design of incandescent filament bulbs while providing significant energy savings. These lamps contain LED emitters in linear filament style rods that are powered by using a glass insulated circuit, similar to a vintage incandescent light bulbs. The perfect replacement for your existing incandescent light bulbs with 15,000 hours average rated life and energy savings of up to 70%. naturalLED[®] offers a full line in A19, G25, ST19, and Candelabra lamps that deliver a warm light in 2200K and tinted glass. Designed for decorative residential, retail, hotel boutiques, hospitality, restaurants, and many more applications.



FEATURES

- Energy star certified
- UL wet/UL damp locations
- Title20/JA8-2016
- Warm light 2200K
- Instant on / Uniform and consistent color
- Up to 70% energy savings
- Omni-directional
- Direct Replacement traditional incandescent design
- Suitable for outdoor usage
- Contains no mercury or lead
- Input line voltage: 120V
- CRI: 90
- Power Factor: >0.9
- Dimmable
- Operating temperature: -4°F - 104°F
- Finish: Tinted Glass
- 15,000 hrs rated average life

APPLICATIONS

- Residential Lighting
- Decorative Lighting
- Retail Lighting
- Restaurant Lighting
- Hospitality Lighting

WARRANTY

- 3 Year Warranty

| Ordering Information | | EXAMPLE: LED4.5CAF/FIL/E12/30L/922 | | | | |
|----------------------|---------------|------------------------------------|--------------|----------------|---------|----------------------|
| LED | 4.5 | CAF | FIL | E12 | 30L | 922 |
| | Wattage | Category | Style | Base | Lumen | CRI/Color Temp |
| LED | 4.5 4.5-Watts | CAF Candelabra | FIL Filament | E12 Candelabra | 30L 300 | 9 CRI 90 22 2200K |

ORDERING

W= Wet Location D=Damp Location

| Watts (W) | Ordering Code | Description | Color Temp (K) | Lumens (lm) | Base | Equiv. Wattage (W) | Bulb Shape | Rated Hrs | Wet/Damp Location | Energy Star JA8 T20 |
|-----------|---------------|---------------------------|----------------|-------------|------|--------------------|------------|-----------|-------------------|---------------------|
| 4.5 | 5940 | LED4.5CAF/FIL/E12/30L/922 | 2200K | 300 | E12 | 40 | Candle | 15,000 | W | • |
| 5 | 5941 | LED5CAF/FIL/E26/32L/922 | 2200K | 325 | E26 | 40 | Candle | 15,000 | W | - |
| 5 | 5942 | LED5G25/FIL/35L/922 | 2200K | 350 | E26 | 40 | G25 | 15,000 | W | • |
| 6.5 | 5994 | LED6.5A19/FIL/45L/922 | 2200K | 455 | E26 | 40 | A19 | 15,000 | D | • |
| 6.5 | 5995 | LED6.5ST19/FIL/45L/922 | 2200K | 450 | E26 | 40 | ST19 | 15,000 | D | • |

PHOTOMETRICS CHART

CAF (4.5 Watt)

E12 Base

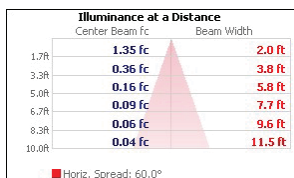
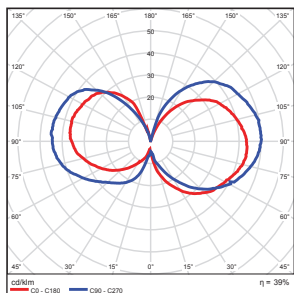

CAF (5 Watt)

E26 Base

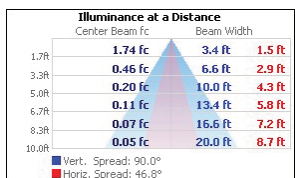
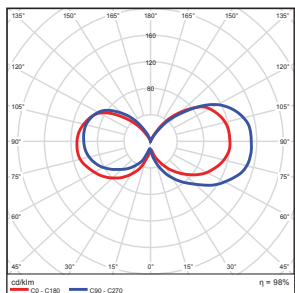

G (5 Watt)

E26 Base

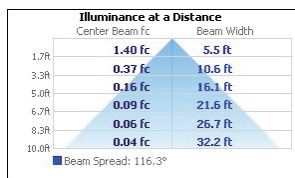
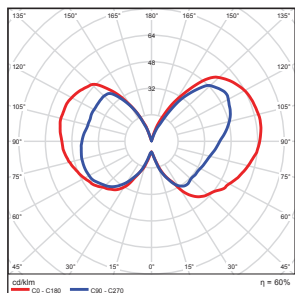

A19 (6.5 Watt)

E26 Base

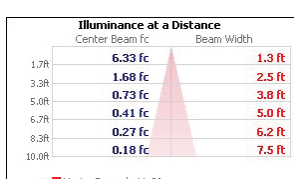
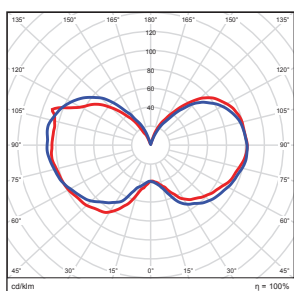

ST19 (6.5 Watt)

E26 Base

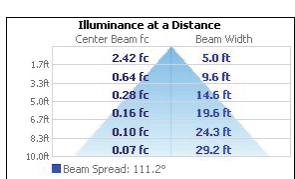
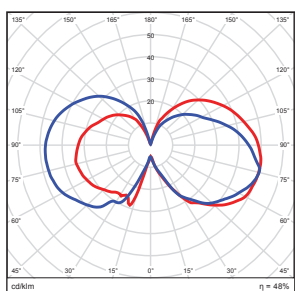

SPECIFICATIONS

Candle E12

Weight: 1.57-oz

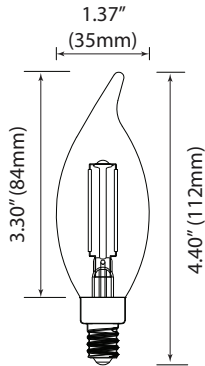

Candle E26

Weight: 1.90-oz

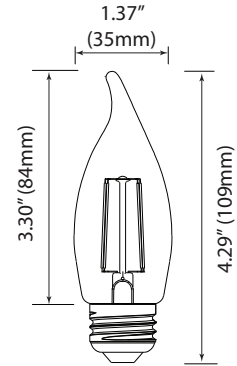

G25

Weight: 4.66-oz

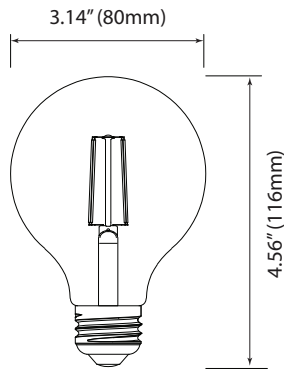

A19

Weight: 4.22-oz

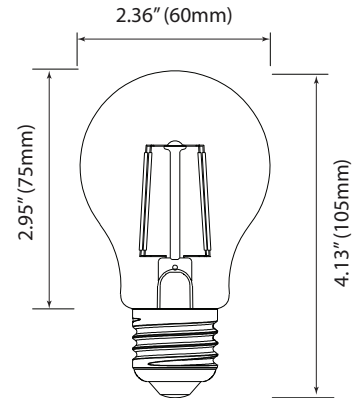

ST19

Weight: 4.30-oz

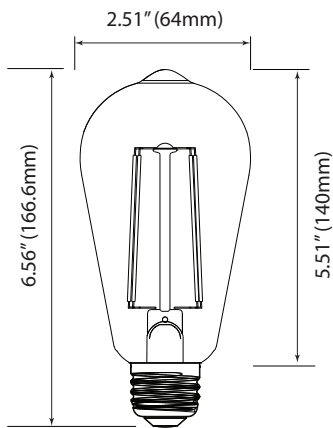

PACKAGE

