



VOL : VOLUMETRIC LED TROFFER

FEATURES

- Architectural recessed luminaire with lumens up to 15,000
- Direct/indirect illumination for visual comfort with minimal glare
- Clean line styling complements today's modern office decor
- One for one alternative LED solution to fluorescent luminaires/ fixtures/troffers
- PowerSet feature allows for multiple "set and forget" lumen stops in each fixture
- FieldCCeT feature allows for multiple "set and forget" CCT options in each fixture
- Up to 50% energy savings over fluorescent troffers
- 0-10V dimmable standard
- Up to 150 lumens per watt
- Available in 2'x2' and 2'x4'

LISTINGS

- UL Listed for dry/damp locations
- IC Rated for insulation contact
- Suitable for premium qualified rebates

LED CHARACTERISTICS

- Rated lifetime L90: >54,000hrs
- PowerSet: 40/32/26W, 50/40/32W, and 85/70/60W selectable
- FieldCCeT: 3500K/4000K/5000K selectable
- CRI: >80

ELECTRICAL

- Input voltage: 120-347V; 120-277V
- Dimming Control: 0-10V (Dim-to-Off)
- Power Factor: >.90
- THD: <10%

CONSTRUCTION

- Reflector precision die-formed, powder-coated, steel construction
- Custom extruded acrylic lens provides even illumination and visual comfort
- Integral earthquake clips
- -4°F to 104°F (-20°C to 40°C) operating temperature

WARRANTY

- 5 year limited warranty; see eiko.com for warranty details
- Additional warranty options available; consult EiKO for details

project name	type
catalog number	
comments	voltage
approved by	date



2x2



2x4

APPLICATIONS

- Conference rooms
- Retail
- Offices
- Hospitality
- Healthcare
- Schools
- Reception areas
- Corridors
- Foyer



ORDERING INFORMATION

EXAMPLE: VOL22/PS40/835/HD

Model	Size	Package	CRI/CCT	Voltage	Dimming	Options
VOL : Volumetric Troffer	22 - 2'x2' 24 - 2'x4'	PS40 - 40/32/26W; 5,000/4,000/3,250lm PS50 - 50/40/32W; 6,250/5,000/4,000lm PS85 - 85/70/60W; 12,750/10,800/9,000lm	835 - 80CRI; 3500K 840 - 80CRI; 4000K 850 - 80CRI; 5000K FCCT - 80CRI; 35/40/5000K	U - 120-277V H - 120-347V	D - 0-10V Dimming	Additional options available; see p. 2

PERFORMANCE SUMMARY

Order Code	Item #	Watts	Nominal Lumens	LPW (Typical)	CCT	CRI	Volts	Fluor. Equiv.	DLC Premium
10995	VOL22/PS40/FCCT/HD	40/32/26W	5000/4000/3250	130	35/40/5000K	>80	120-347V	3x 17WT8, 2U31T8	✓
10992	VOL22/PS40/835/HD	40/32/26W	5000/4000/3250	130	3500K	>80	120-347V	3x 17WT8, 2U31T8	✓
10993	VOL22/PS40/840/HD	40/32/26W	5000/4000/3250	130	4000K	>80	120-347V	3x 17WT8, 2U31T8	✓
10994	VOL22/PS40/850/HD	40/32/26W	5000/4000/3250	130	5000K	>80	120-347V	3x 17WT8, 2U31T8	✓
10999	VOL24/PS50/FCCT/HD	50/40/32W	6250/5000/4000	130	35/40/5000K	>80	120-347V	2x 32T8, 3x 32T8	✓
10996	VOL24/PS50/835/HD	50/40/32W	6250/5000/4000	130	3500K	>80	120-347V	2x 32T8, 3x 32T8	✓
10997	VOL24/PS50/840/HD	50/40/32W	6250/5000/4000	130	4000K	>80	120-347V	2x 32T8, 3x 32T8	✓
10998	VOL24/PS50/850/HD	50/40/32W	6250/5000/4000	130	5000K	>80	120-347V	2x 32T8, 3x 32T8	✓
11471	VOL24/PS85/835/UD	85/70/60W	12,750/10,800/9,000	150	3500K	>80	120-277V	6x T8, 4x T5	✓
11472	VOL24/PS85/840/UD	85/70/60W	12,750/10,800/9,000	150	4000K	>80	120-277V	6x T8, 4x T5	✓
11473	VOL24/PS85/850/UD	85/70/60W	12,750/10,800/9,000	150	5000K	>80	120-277V	6x T8, 4x T5	✓

FACTORY INSTALLED OPTIONS

EXAMPLE: VOL24/PS85/835/UD-EM30W

EM5W - 5W Emergency Battery*
EM7.8W - 7.8W Emergency Battery*
EM8W - 8W Emergency Battery*

EM15W - 15W Emergency Battery*
EM20W - 20W Emergency Battery*
EM30W - 30W Emergency Battery*

*120-277V only

AVAILABLE ACCESSORIES

Order Code	Item #	Description
09898	VOL22-SMK-W	2x2 Surface Mount Kit, White
09899	VOL24-SMK-W	2x4 Surface Mount Kit, White
10366	SLM22-RMK-A	2x2 Recessed Mount Kit, White
10368	SLM24-RMK-A	2x4 Recessed Mount Kit, White

DIMENSIONS

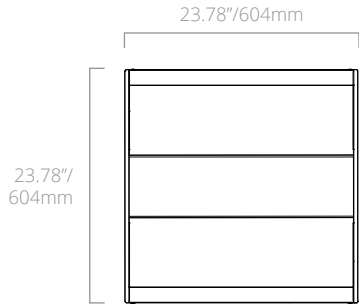

VOL22

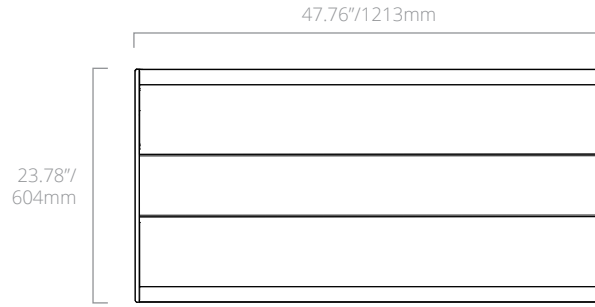

VOL24

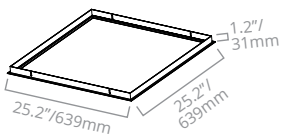

SLM22-RMK-A

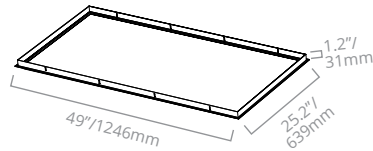

SLM24-RMK-A

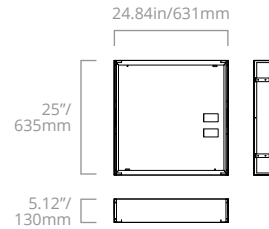

VOL22-SMK-W

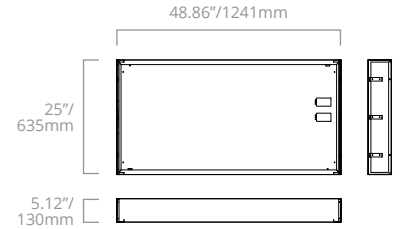

VOL24-SMK-W

PHOTOMETRICS

VOL22/PS40/840/HD (Typical performance @40W)

ZONAL LUMEN SUMMARY		
Zone	Lumens	%Fixture
0-30	1278.43	25.6%
0-40	2090.09	41.8%
0-60	3739.43	74.8%
0-80	4835.5	96.7%
0-90	4986.19	99.7%
60-80	1096.08	21.9%
70-80	441.86	8.8%
80-90	150.69	3.0%
0-180	5002.21	100%

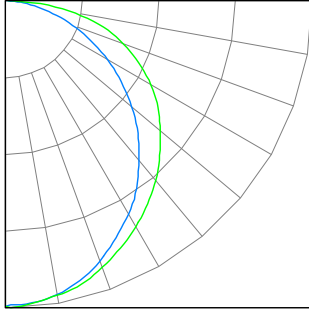

VOL24/PS50/840/HD (Typical performance @50W)

ZONAL LUMEN SUMMARY		
Zone	Lumens	%Fixture
0-30	1342.03	25.1%
0-40	2200.93	41.1%
0-60	3963.00	74.1%
0-80	5161.42	96.5%
0-90	5332.91	99.7%
60-80	1198.42	22.4%
70-80	487.49	9.1%
80-90	171.49	3.2%
0-180	5349.24	100%

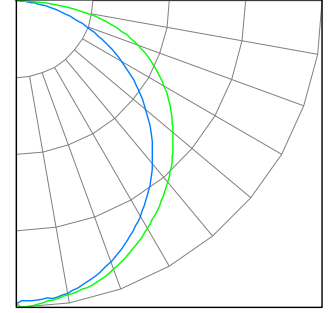

VOL22/PS40/FCCT/HD (Typical performance @40W)

ZONAL LUMEN SUMMARY		
Zone	Lumens	%Fixture
0-30	1364.48	25.6%
0-40	2231.37	41.9%
0-60	3994.32	75.0%
0-80	5160.86	96.9%
0-90	5310.28	99.7%
60-80	1166.54	21.9%
70-80	467.36	8.8%
80-90	149.42	2.8%
0-180	5324.78	100%

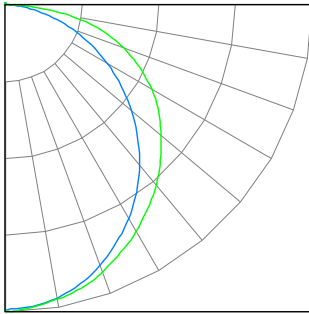

VOL24/PS50/FCCT/HD (Typical performance @50W)

ZONAL LUMEN SUMMARY		
Zone	Lumens	%Fixture
0-30	1374.86	25.1%
0-40	2255.59	41.2%
0-60	4064.23	74.2%
0-80	5292.26	96.6%
0-90	5462.18	99.7%
60-80	1228.03	22.4%
70-80	497.99	9.1%
80-90	169.92	3.1%
0-180	5477.54	100%

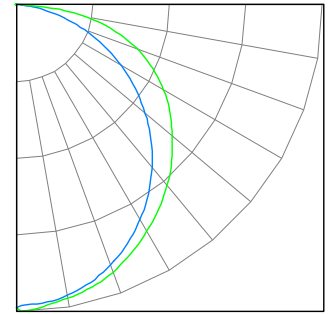

VOL24/PS85/840/UD (Typical performance @85W)

ZONAL LUMEN SUMMARY		
Zone	Lumens	%Fixture
0-30	TBD	TBD
0-40	TBD	TBD
0-60	TBD	TBD
0-80	TBD	TBD
0-90	TBD	TBD
60-80	TBD	TBD
70-80	TBD	TBD
80-90	TBD	TBD
0-180	TBD	TBD

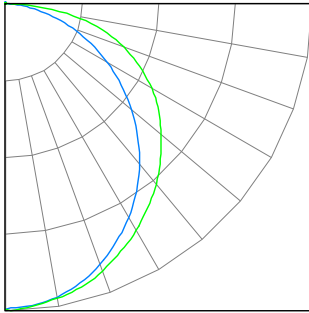

SCALING FACTORS

FIXTURE	WATTS	CCT			
		3500K	4000K	5000K	
VOL22	PowerSet	40	1.00	1.00	1.02
		32	0.84	0.84	0.86
		26	0.71	0.71	0.72
	PowerSet FieldCct	40	0.94	1.00	0.96
		32	0.77	0.82	0.79
		26	0.65	0.69	0.66
VOL24	PowerSet PS85	85	0.99	1.00	0.99
		72	0.84	0.84	0.84
		60	0.73	0.73	0.73
	PowerSet PS50	50	0.98	1.00	1.01
		40	0.79	0.81	0.82
		32	0.66	0.67	0.68
	PowerSet FieldCct	50	0.94	1.00	0.96
		40	0.74	0.79	0.76
		32	0.62	0.66	0.63