

- <4W Input Power
- 500 Lumen output
- To be operated with FHS1-UNV-3.6L only
- Wall Sconce and Ceiling Flush Mount compatible
- Low Level Lighting
- Linear arrays are linkable

General Specifications

Universal Voltage *	120V - 277V ± 10%, 47-63Hz
Surge Protection	C62.41 (TVS)
Over Current Protection	Fuse
Input Current	0.07A
Input Power *	<4W
Lumen Output *	500 Lumens
Maximum Output Current	2.1 Amp. when used with # FHSBATT3-C3
Output Voltage	3.6V
Output Short Circuit Protection	Self resetting PTC
Recharge Time Required	24 Hrs.
Battery Type	NiCd 3.6VDC
Battery Capacity Available	3Ah
Illumination Time	Minimum 90 min
Estimated Run Time	145 Min.
Output Classification	UL 1310 / Class 2
Ambient Temperature	0°C - 50°C
Warranty	5 Years

HotSpot UL Classified Kit components



***For further detailed instructions and list of kit components please refer to the Installation Instructions.**

*Self-Diagnostic Standard.
 *Self-Diagnostic comes factory disabled.
 Please reference pg.4 for more details.

Part Number Matrix

FHS

Product Line
FHS = HotSpot

KIT

KIT

T

Retrofit Type
T = Troffer

04

LED Wattage
04 = 4W

LN

LED Type
LN = Linear

C

Battery Type
C = C Cell

Mechanical Data

FHS1-UNV-3.6L

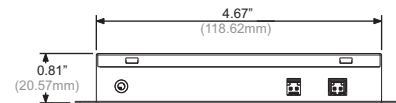
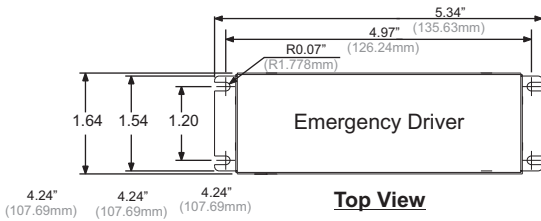

FHSBATT3-C3

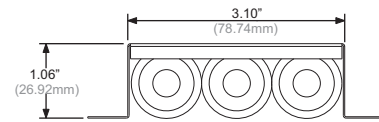
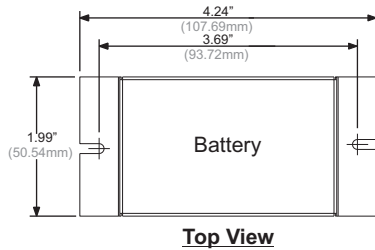

FHS6-AR-3W-L LINEAR MODULE

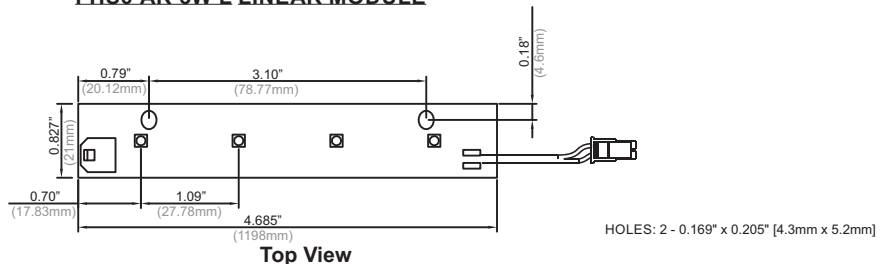

Wiring Diagram

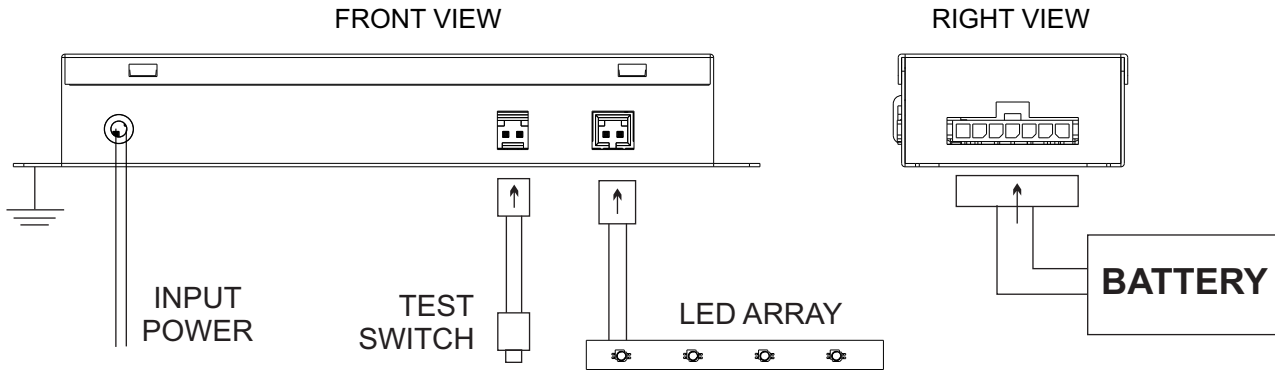

WIRING DIAGRAM (TYP)

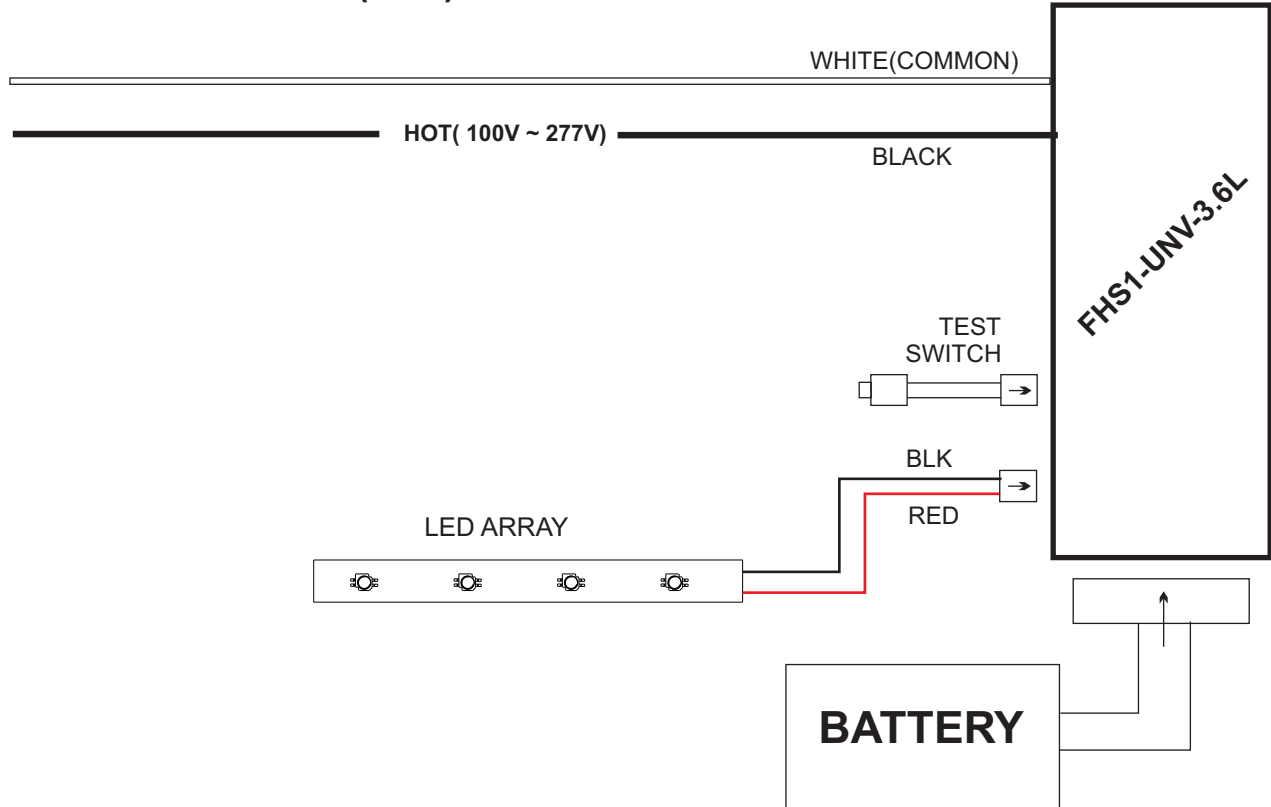

WIRE	BLACK	WHITE	BATTERY-LED ARRAY-TEST SWITCH-PILOT LIGHT
LENGTH - INCHES	12 ± 1"	12 ± 1"	24 ± 1"

Test Switch Indicator Status

FHS1-UNV-3.6L Status Indication - Single Color Indicator			
LED indicator	Status	Comment	Note
Permanent Red Light/Solid	System OK	AC mode	
Blinking ON (4.5 sec on – 0.5 sec off)	Self-diagnose test underway	Self-Diagnostic	
Blinking OFF (0.5 sec on – 4.5 sec off)	Charge circuit is broken	Replace EM Driver	
Fast Flashing (0.5 sec on - 0.5 sec off)	Battery not connected	Connect battery pack.	
Fast Flashing (0.5 sec on - 0.5 sec off)	Battery failure	Change the battery	
Very Slow Flashing (4 sec on – 4 sec off)	Over Circuit Protection Error Triggered.	Check LED load or check EM driver.	AC power will need to be cycled on/off as well as the battery re-connected

TEST SWITCH OPERATIONS:

1. EM TEST : Press and hold test button for more than one second to enter EM mode for testing.
2. Manual Self-Diagnostic : After charging the battery for the specified recharge time, quickly press the test button three times within two seconds to force the controller to enter a Self-Diagnostic cycle. To quit the self-diagnostic cycle after engaged press and hold the test button for ten seconds.
3. Enable/Disable Self-Diagnostic Status : Quickly press the test button two times within two seconds ,the monochromatic lamp displays the status of Self-Diagnostic Enable / Disabled settings.
4. Enable/Disable Auto Self-Diagnostic : Press and hold the test button for two seconds, then release and quickly press the test button two times, then release and press and hold the test button for two more seconds. When properly executed the indicator on the test button will display the flash mode for the Enable/Disable status. A flash of 2.5S on - 0.5S off means "Enabled", while a flash of 0.5S on - 2.5S off means "Disabled", the flashing will last for a few cycles.

SELF- DIAGNOSTIC INSTRUCTIONS / OPERATION:

If the self-diagnostic feature is enabled:

The emergency LED driver will conduct a self-check for thirty (30) seconds every thirty (30) days; and a ninety (90) minute self-check every 12 months. After every self-check the LED indicator light will indicate a status signal. Check indicator status chart above to diagnose the status signal.

If the self-diagnostic feature is disabled:

User must conduct a manual test every thirty (30) days to ensure the emergency LED light source illuminates as intended. A full discharge test shall be conducted once a year; the LED light source shall illuminate for a minimum of ninety (90) minutes.

***Self-Diagnostic feature is factory disabled**