

**LROAD**<sup>TM</sup>  
LED ROADWAY



# New LED Roadway Lighting Family

For everything from pathways to expressways.



Free trial program. Leasing options. Great design and performance.



Please visit [rabweb.com](http://rabweb.com) to see which models are DLC Premium or DLC listed.

**RAB**<sup>®</sup>  
LIGHTING  
RABWEB.COM • 888-722-1000

# LROAD™ ROADWAY LIGHT



- 100,000 Hour LED Lifespan = 27 years without relamping
- RAB's 10-Year No Compromise Warranty covers full fixture and finish, plus lumen maintenance and color shift.
- Roadway arm mount versions DLC Listed
- Free trial program and leasing options available
- Industry-leading 5G vibration rating per ANSI C136.31
- Available in IES Distribution Types II, III and IV

	Equivalency	Output Lumens	Mounting Ht.	Applications
LROAD 50W	200W MH	7,195	15 feet	<ul style="list-style-type: none"> <li>• Alleys</li> <li>• Bike paths</li> <li>• Walking paths</li> </ul>
LROAD 78W	250W MH	10,157	25 feet	<ul style="list-style-type: none"> <li>• Local roads</li> <li>• Collector roads</li> </ul>
LROAD 105W	320W MH	13,680	25 feet	<ul style="list-style-type: none"> <li>• Major roads</li> </ul>
LROAD 125W	350W MH	16,328	35 feet	<ul style="list-style-type: none"> <li>• Expressways</li> </ul>
LROAD 150W	400W MH	18,464	35 feet	<ul style="list-style-type: none"> <li>• Expressways</li> </ul>

# Major Roads & Expressways

LROAD 105W

LROAD 125W

LROAD 150W

## Roadway Classifications

**Major** - The part of the roadway system that serves as the principle network for through traffic flow. The routes connect areas of principle traffic generation and important rural highways entering the city.

**Expressway (arterial)** - A divided highway for through traffic with some control of access, by using signals or signage at intersections of major crossroads. Expressways for non-commercial traffic within parks and park-like areas generally are known as parkways.

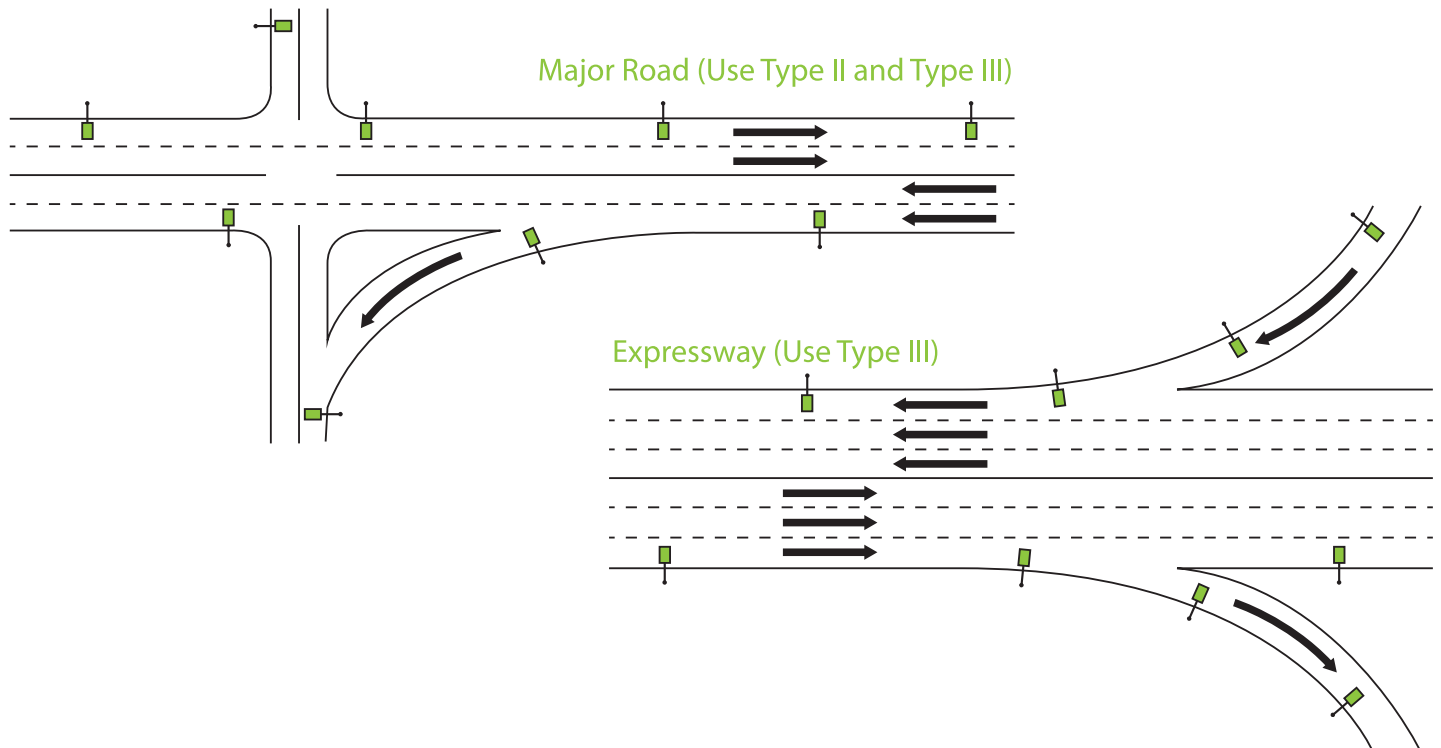

# Local & Collector Roads

## LROAD 78W

### Roadway Classifications

**Local** - Roadways used primarily for direct access to residential, commercial, industrial, or other abutting property. They do not include roadways carrying through traffic. Long local roadways generally will be divided into short sections by collector roadway system.

**Collector** - The distributor and collector roadways serving traffic between major and local roadways. These are roadways used mainly for traffic movements within residential, commercial and industrial areas.

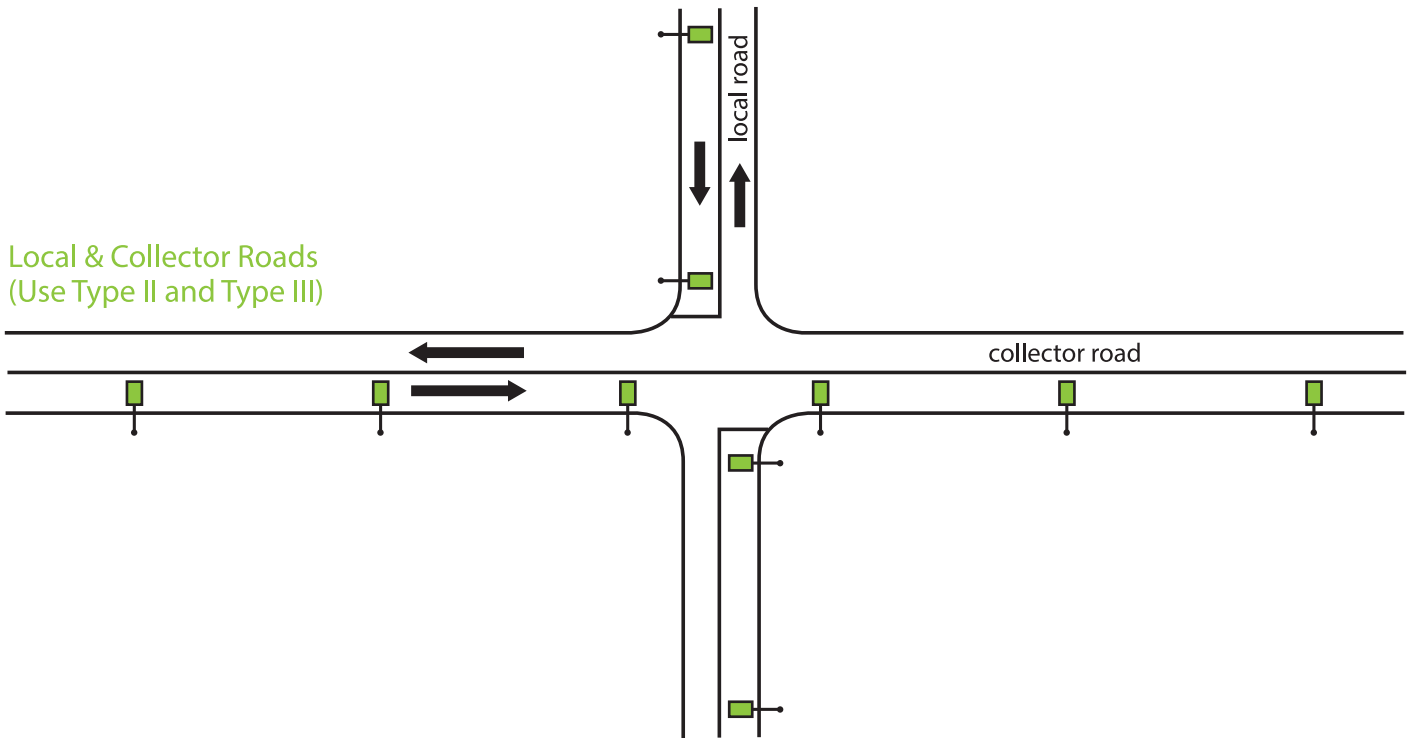

# Intersections

LROAD 78W

LROAD 105W

LROAD 125W

LROAD 150W

## Pedestrian Conflict Classifications - Areas of Low to Medium Volumes

**Medium** - Areas where lesser numbers of pedestrians utilize the streets at night. Typical areas are downtown office areas, blocks with libraries, apartments, neighborhood shopping, industrial, older city areas and streets with transit lines.

**Low** - Areas with very low volumes of night pedestrian usage. These can occur in any area of the cited roadway classifications, but may be typified by suburban single-family streets, very low-density residential developments, and rural or semi-rural areas.

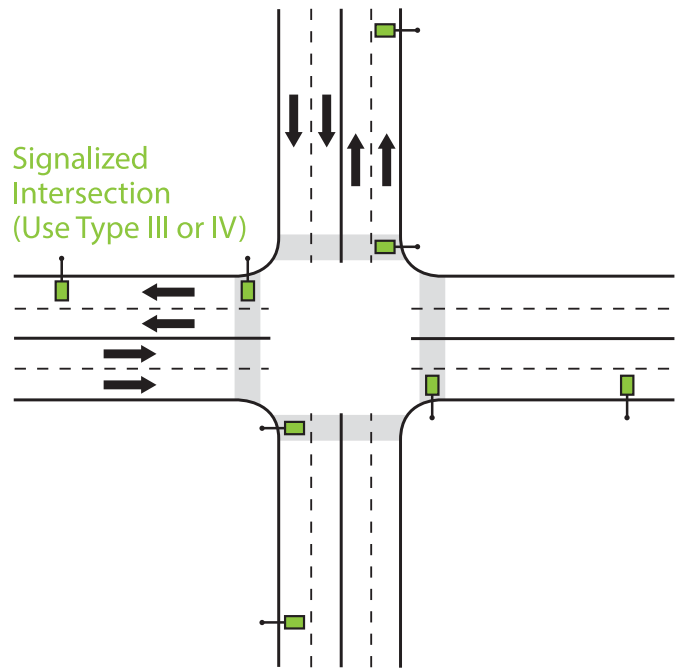
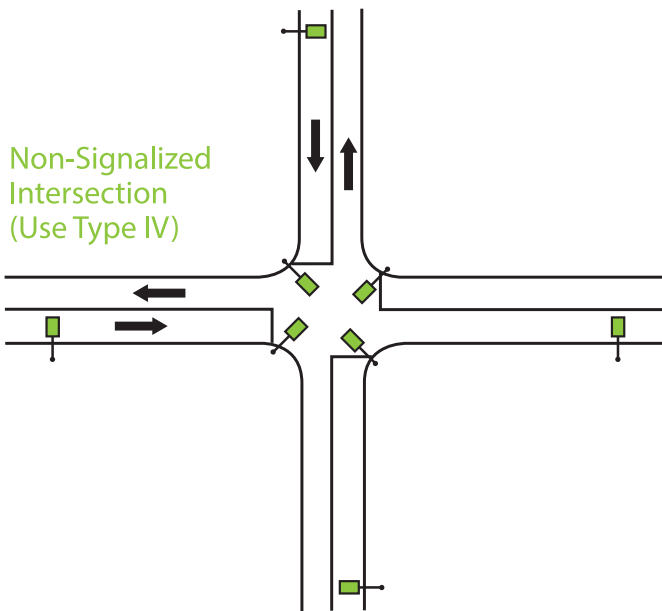



# Alleys, Bike & Walking Paths

## LROAD 50W

### Roadway Classifications

**Alley** - A narrow public way within a block, generally used for vehicular access to the rear of abutting properties.

**Pedestrian Way** - Public sidewalks for pedestrian traffic generally not within rights-of-way for vehicular traffic roadways. Included are skywalks (pedestrian overpasses), subwalks (pedestrian tunnels), walkways giving access to park or block interiors, and crossings near centers of long blocks.

**Bicycle Lane** - Any facility that explicitly provides for bicycle travel.

### Bicycle Lane & Pedestrian Way (Use Type II)

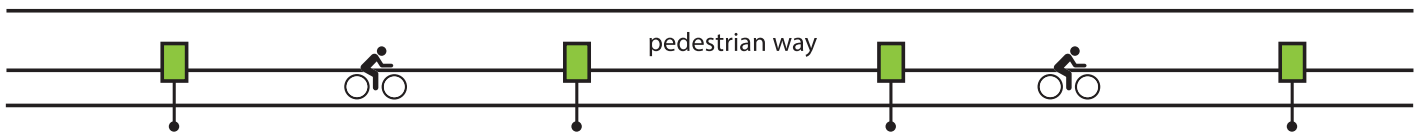

# LROAD™ ROADWAY LIGHT

## Dimensions & Weight

### Roadway Arm

**Weight:** 30 lbs.  
**EPA:** 0.75

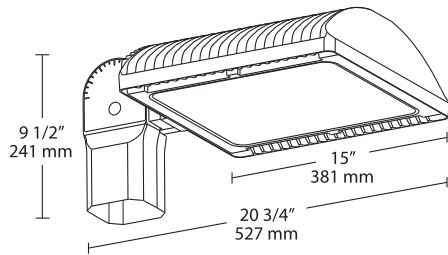
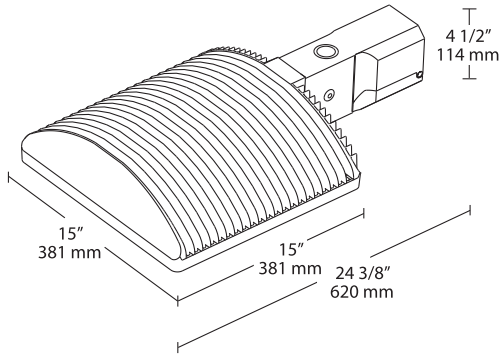

### Slipfitter Model

**Weight:** 32 lbs.  
**EPA:** 2.2

## Mounting Options

Adaptor brackets included to fit roadway arms with 1", 1 1/4", 1 1/2", 2" and 2 3/8" OD.

+/- 5° tilt wedge option for leveling.

Slipfitter option with 180° pivot available for mounting on 2 3/8" tenon.

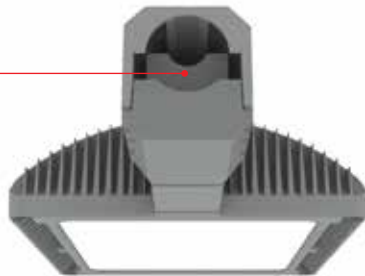

## Accessories

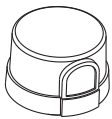

**Twistlock Photocell**  
(for roadway arm models)

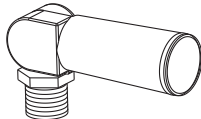

**Swivel Photocell**  
(for slipfitter mount models)

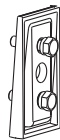

**Tilt Wedge**  
WEDGERW-A (Bronze)  
WEDGERW-RG (Gray)  
WEDGERW-W (White)

## Ordering Information

Product Family	Distribution	Wattage	Mounting	Color Temperature	Finish	Options
<b>RWLED</b>						
	<b>2T</b> Type II	<b>50</b> 50W	<b>Blank</b> Roadway Arm	<b>Blank</b> 5000K	<b>Blank</b> Bronze	<b>/PCT</b> Twistlock Photocell (120-277V) <sup>†</sup>
	<b>3T</b> Type III	<b>78</b> 78W	<b>SF</b> Slipfitter	<b>N</b> 4000K	<b>RG</b> Gray	<b>/PCS</b> Swivel Photocell (120V) <sup>†</sup>
	<b>4T</b> Type IV	<b>105</b> 105W		<b>Y</b> 3000K	<b>W</b> White	<b>/PCS2</b> Swivel Photocell (277V) <sup>†</sup>
		<b>125</b> 125W				<b>/BL</b> Bi-Level Control <sup>††</sup>
		<b>150</b> 150W				<b>/D10</b> 0 - 10V Dimming
						<b>/480</b> 480V Driver <sup>†††</sup>

<sup>†</sup> Twistlock photocell only available for roadway arm models, and swivel photocell only available for slipfitter mount models.

<sup>††</sup> Not available for 105W models.

<sup>†††</sup> Only available for 78W models.

## Specifications

**UL Listing:** Suitable for wet locations as a downlight.

**LEDs:** Multi-chip, high-output, long-life LEDs

**Lumen Maintenance:** 100,000-hour LED lifespan based on IES LM-80 results and TM-21 calculations

**Drivers:** Class 2, 100 - 277V, 50/60 Hz, 4 kV surge protection tested in accordance with IEEE/ANSI C62.41.2

**IP Rating:** IP66

Input Watts @120V	50W	78W	105W	125W	150W
<b>Output Lumens*</b>	7,195	10,157	13,680	16,328	18,464
<b>Lumens Per Watt*</b>	132	132	125	121	119
<b>Color Accuracy (CRI)*</b>	71	71	71	71	71

**Cold Weather Starting:** The minimum starting temperature is -40°C.

**Thermal Management:** Superior patent pending thermal management design with external Air-Flow fins provides maximum operational life even in higher ambient temperature environments.

**Housing:** Die-cast aluminum housing, lens frame and mounting arm

**Mounting:** Fits most standard roadway upsweep arms. Adaptor brackets supplied fit 1", 1 1/4", 1 1/2" and 2" OD arms. 2" adaptor is for 2 3/8" OD pipe.

**Color Stability:** RAB LEDs exceed industry standards for chromatic stability

**Color Uniformity:** RAB's range of CCT (Correlated Color Temperature) follows the guidelines of the American National Standard for Specifications for the Chromaticity of Solid State Lighting (SSL) Products, ANSI C78.377-2015.

**Reflector:** Specular vacuum-metallized polycarbonate

**Gaskets:** High-temperature silicone gaskets

**Finish:** Our environmentally friendly polyester powder coatings are formulated for high-durability and long-lasting color, and contain no VOC or toxic heavy metals.

**IESNA LM-79 & LM-80 Testing:** RAB LED luminaires have been tested by an independent laboratory in accordance with IESNA LM-79 and LM-80, and have received the Department of Energy "Lighting Facts" label.

**California Title 24:** RWLED50 with available photocell option complies with 2013 California Title 24 building and electrical codes as a commercial outdoor pole-mounted fixture ≤ 75 Watts. Add /PCT for roadway arm version and /PCS for slipfitter version to include a photocell. RWLED78, 105, 125 and 150W with available photocell options comply with 2013 California Title 24 building and electrical codes as commercial outdoor pole-mounted fixtures with mounting heights > 25 feet. Add /PCT for roadway arm version and /PCS for slipfitter version to include a photocell. For mounting heights lower than 24 feet, use LROAD catalog numbers with /D10 suffix and purchase with RAB's STLDIM10 photo and motion sensor.

**Green Technology:** Mercury and UV free, and RoHS compliant. Polyester powder coat finish formulated without the use of VOC or toxic heavy metals.

\* Values shown for cool color temperature in Type IV. Visit [rabweb.com](http://rabweb.com) for Type II and III, and for neutral and warm.