



Low-profile vandal-resistant fixture covers the footprint of most traditional canopy lights. Available in flat or drop lens with frosted and unfrosted options.

Color: Bronze

Weight: 10.0 lbs

Project:

Type:

Prepared By:

Date:

Driver Info

Type	Constant Current
120V	0.19A
208V	0.12A
240V	0.1A
277V	0.09A
Input Watts	21.80W
Efficiency	92%

LED Info

Watts	20.00W
Color Temp	5000K (Cool)
Color Accuracy	84 CRI
L70 Lifespan	100,000
Lumens	2,989
Efficacy	137.1 LPW

Technical Specifications

Listings

UL Listing:

Suitable for Wet Locations. Covered Ceiling Mount Only.

IESNA LM-79 & LM-80 Testing:

RAB LED luminaires and LED components have been tested by an independent laboratory in accordance with IESNA LM-79 and LM-80.

Electrical

Driver:

Class 2, Constant Current, 120-277V, 50-60Hz, 120V: 0.19A, 208V: 0.12A, 240V: 0.1A, 277V: 0.09A

Dimming Driver:

Driver includes dimming control wiring for 0-10V dimming systems. Requires separate 0-10V DC dimming circuit. Dims as low as 10%.

THD:

8.33% at 120V, 7.24% at 277V

Power Factor:

99.8% at 120V, 94.8% at 277V

LED Characteristics

LEDs:

Long-life, high-efficacy surface mount LEDs

Color Stability:

RAB LEDs exceed industry standards for chromatic stability

Color Uniformity:

RAB's range of CCT (Correlated Color Temperature) follows the guidelines of the American National Standard for Specifications for the Chromaticity of Solid State Lighting (SSL) Products, ANSI C78.377-2017.

Construction

Maximum Ambient Temperature:

Suitable for use in 40°C (104°F)

Cold Weather Starting:

Minimum starting temperature is -40°C (-40°F)

Lens:

Vandal-resistant polycarbonate textured opaque for low glare drop lens

Housing:

Die-cast aluminum housing and lens frame with (4) 1/2" NPS side conduit entries and weatherproof rear wire plug and access plate

Mounting:

Ceiling mount to recessed junction with knockout template or directly to ceiling surface, utilizing side conduit entry points

IP Rating:

Ingress Protection rating of IP66 for dust and water

Air Tight:

Housing certified Air Tight as per ASTM E283

Finish:

Our environmentally friendly polyester powder coatings are formulated for high-durability and long-lasting color

Other

Warranty:

RAB warrants that our LED products will be free from defects in materials and workmanship for a period of five (5) years from the date of delivery to the end user, including coverage of light output, color stability, driver performance and fixture finish. RAB's warranty is subject to all terms and conditions found at rablighting.com/warranty.

Buy American Act Compliance:

RAB values USA manufacturing! Upon request, RAB may be able to manufacture this product to be compliant with the Buy American Act (BAA). Please contact customer service to request a quote for the product to be made BAA compliant.

Dimensions

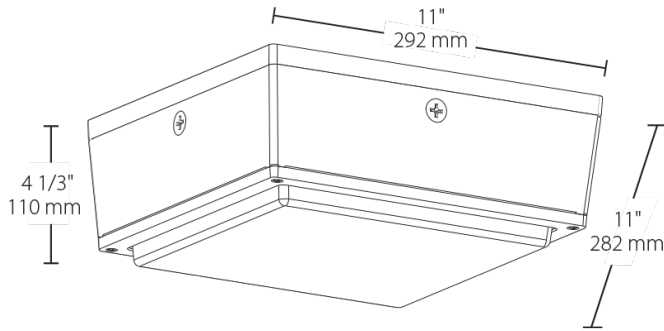

Features

- Fits the footprint of older canopy lights
- Vandal resistant and UV resistant lens
- Ultra-high efficiency
- Clean, contemporary, low-profile design
- Available with drop lens or flat lens
- IP66 rated, keeps dust, bugs and water out
- Photo and motion sensor options available

Ordering Matrix

Family	Wattage	Color Temp	Lens-Optics	Finish	Voltage	Option-Motion Sensor	Options-Control	Options-Lightcloud	Options-Emergency	Suffix
VANLED	20									
	10 = 10W 20 = 20W 28 = 28W 40 = 40W 52 = 52W 65 = 65W 75 = 75W	Blank = 5000K (Cool) N = 4000K (Neutral) Y = 3000K (Warm)	Blank = Drop lens F = Flat lens FR = Frosted Drop Lens FFR = Frosted Flat Lens	Blank = Bronze W = White	Blank = 120-277V, 0-10V Dim Standard /480 = 480V, 0-10V Dim Standard	Blank = No Option (Standard) /MVS = Microwave Sensor /WS = Wattstopper, 8ft /WS2 = Wattstopper, 20ft	Blank = No Options /PCS = 120V Swivel Photocell /PCS2 = 277V Swivel Photocell /PCS4 = 480V Swivel Photocell	Blank = No Option (Standard) /LC = Lightcloud® Control factory Installed	Blank = No Options /E2 = Emergency Battery, 120-277V only	Blank = Standard USA = Complies with the BAA