

WPFC Wall Pack

Outdoor



The WPFC Wall Pack is tuned for high visual quality at night and is ideal for illumination of stairways, tunnels, building perimeters, overpasses, and parking garages. eLucent WPFC fixtures are rated for use in wet locations and can operate in ambient temperatures from -40° to 40°C.



Luminaire	WPFC	Type
Project		
Product		
Notes		

- Features**
- Recommended mounting height between 8' and 20'
 - IP65 Rated
 - Polycarbonate lens fitted for uniform light distribution



Order Format

Sample: WPFC-40-50-G2

Series	Wattage	CCT	Voltage	Dimming	Generation	Finish Color
WPFC=WPFC Wall Pack	- 28=28W 40=40W 60=60W 90=90W	- 40=4000K 50=5000K	- Blank=100-277V V=347-480V	- Blank=1-10V Dimming ND=Non-Dimming	- G2	Blank=Standard

Application

Convenient, modular design means the eLucent wall pack may be mounted to nearly any vertical surface. Recommended mounting height is between 8' and 20'.

Construction
eLucent WPFC housing is manufactured within precise tolerances from heavy-wall, die-cast aluminum. Integrated heat management promotes operating efficiency as well as longevity of components. The eLucent WPFC is tested for use in wet locations (IP65).

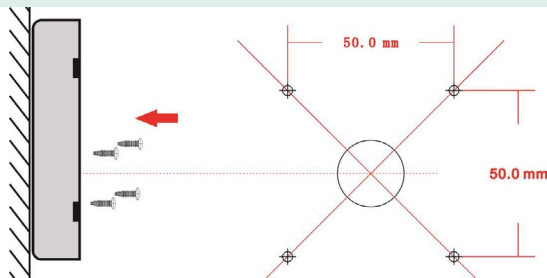

Electrical

Input voltage is a standard 120-277V, with optional 347-480V drivers. Fixture lifespan is rated for 63,000 hours. Luminous efficacy is 119 Lm/W or greater with fixture lifespan rated for 63,000 hours. 40W, 60W, and 90W models are standard, with a 28W available for direct factory order.

Input Voltage (VAC)	120-277 347-480
CRI	80+
CCT(K)	4000*, 5000
PF	>.9
THD	<20%
L70 (Hours)	63,000
Color	Bronze
Housing	Die Cast Aluminum
Optic Types	Clear Glass
Temperature Range	-40°C to 40°C
Warranty	10 Years

Optics
The eLucent WPFC Wall Packs lead their segment for optical performance. With CRI over 80 across standard offerings of CCT 4000K and 5000K, these fixtures offer excellent performance over a broad band of application requirements. The lens is clear polycarbonate carefully fitted for uniform light distribution. Output is tuned for a superior balance of performance and visual comfort.

- Certifications**
- DLC Premium
 - ETL listed
 - IP65 rated
 - CE
 - RoHS
 - Title 24

*contact sales for lead time

Lumen Data

Wattage (W)	4K		5K	
	Efficacy (Lm/W)	Lumens (Lm)	Efficacy (Lm/W)	Lumens (Lm)
28W	128	3,580	131	3,668
40W	123	4,920	125	5,000
60W	124	7,440	126	7,440
90W	123	11,070	125	11,250

Dimensions

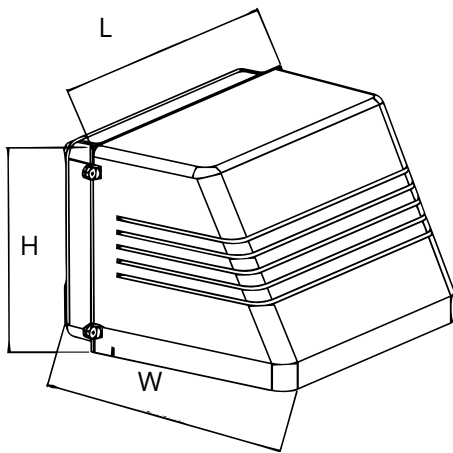

Part No.	Length (L)	Width(W)	Height(H)
WPFC-28	14.27	11.77	9.15
WPFC-40	14.27	11.77	9.15
WPFC-60	14.27	11.77	9.15
WPFC-90	14.27	11.77	9.15

Recorded in inches

Coverage

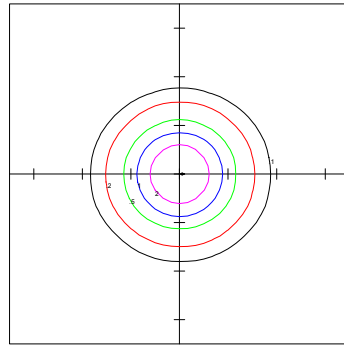

WPFC-28W-40K @16'

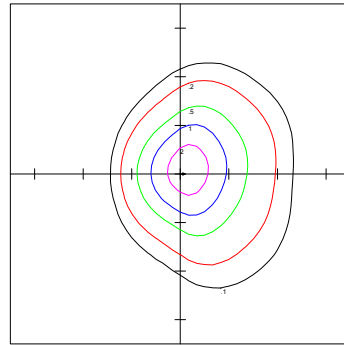

WPFC-28W-T3-40K @16'

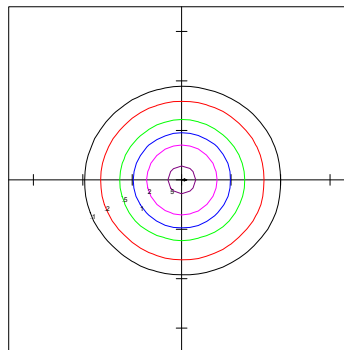

WPFC-40W-40K @16'

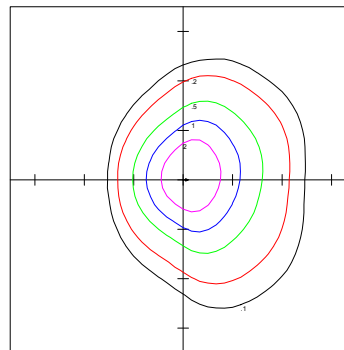

WPFC-40W-T3-40K @16'

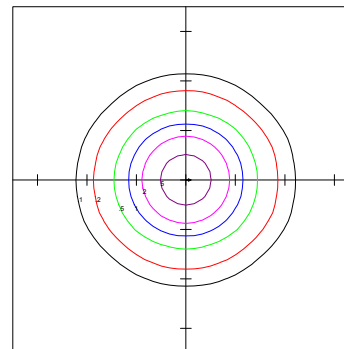

WPFC-60W-40K @16'

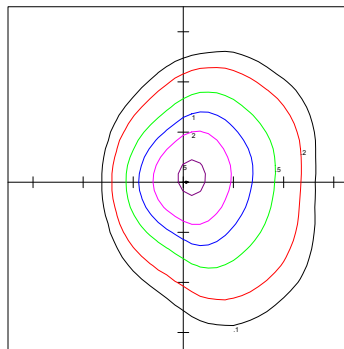

WPFC-60W-T3-40K @16'

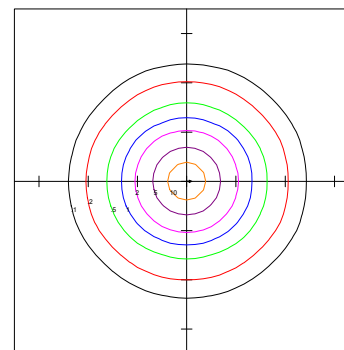

WPFC-90W-40K @16'

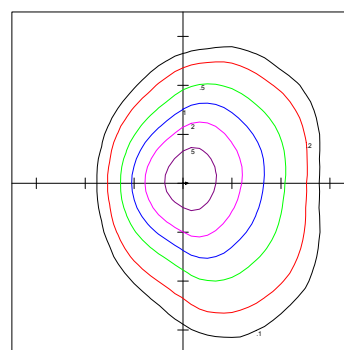

WPFC-90W-T3-40K @16'

10 Year Warranty

ATG Electronics®
Industry Leading 10 Year Limited Warranty
For North American LED Lighting Fixtures

ATG Electronics warrants to the original purchaser of ATG Electronics Domestic LED products listed above that were manufactured for which the ATG Electronics Spec Sheet located on our website contains the words "10 year limited warranty" that, subject to the below terms and conditions of this warranty, when such LED products are properly installed they will comply with ATG Electronics published product specifications for such products and will be free from material defects in material and workmanship for a period of ten (10) years from the date of sale by ATG Electronics, or, if lesser, 50,000 hours of operation (at an average of 13.6 hours per day operation). The LED arrays in the Product(s) will be considered defective in material or workmanship only if a total of 15% or more of the individual light emitting diodes in the Product(s) fail to illuminate.

The above express limited warranty is extended by ATG Electronics® only to the original or first end-user purchaser and only for the original installed location. This warranty only applies to products purchased after June 1, 2017. This warranty is non-transferrable, whether by assignment or operation of law. The original purchaser must provide warranty claims to ATG Electronics within the warranty period promptly upon discovery and in accordance with ATG Electronics Return and Repair Procedures as outlined within this document.

Should any defects be found by ATG Electronics upon its inspection of the properly returned product, ATG Electronics sole responsibility and liability under this warranty will be, at its option, to either repair or replace the defective part or parts or else make available a new replacement unit that will provide equal or better performance. All decisions regarding the existence or non-existence of defects or otherwise affecting the warranty shall be made by ATG ELECTRONICS and shall be final and binding on all parties. Where a defective LED product is replaced under this warranty, the balance of the original warranty period shall remain effective.

Conditions and Exclusions

This warranty is conditioned upon proper installation, use and maintenance. This warranty will automatically become null and void and shall not be applicable to any LED fixture which (i) has not been timely paid for, (ii) is not installed and operated in accordance with the current edition of The National Electric Code (NEC), the Standards for Safety of Underwriters' Laboratory, Inc. (UL) or with ATG Electronics instructions and guidelines, (iii) has been moved from its original installation, (iv) has been installed within an area that has exposure to sulfur or any area with high acidic compounds in use, (v) has been operated in an ambient temperature or humidity that is higher than 35 degrees Celsius, (vi) has been subjected to a lightning strike, power surge or overvoltage condition, (vii) has its LED Board subjected to static electricity due to failure to discharge same prior to connecting or disconnecting the lead from the LED board, (viii) was not installed and/or operated in accordance with ATG Electronics instructions and guidelines, (ix) has been mishandled, misused, abused, tampered with, modified or altered by anyone other than ATG ELECTRONICS, (x) has been subjected to abnormal stresses and operating conditions, or (xi) has been operated without overvoltage and lightning protection devices in place.

Limitations

Disclaimers & Limitations of Liability

The foregoing warranty is exclusive of all other statutory, written or oral warranties and no other warranties of any kind, statutory, by operation of law or course of performance, or otherwise, are given, herein expressed or otherwise received. EXCEPT AS EXPRESSLY PROVIDED ABOVE, ATG ELECTRONICS DISCLAIMS ALL REPRESENTATIONS, WARRANTIES AND CONDITIONS OF ANY KIND, EXPRESS OR IMPLIED, REGARDING THE LED PRODUCTS AND ITS SERVICES, INCLUDING, WITHOUT LIMITATION, THE IMPLIED WARRANTIES OF MERCHANTABILITY AND FITNESS FOR A PARTICULAR USE OR PURPOSE.

LIMITATION OF LIABILITY. Other than the obligation to repair or replace as provided above, ATG Electronics shall have no liability for any losses, expenses or damages as a result of the installation, use, inability to use, removal or replacement of any LED product. ATG Electronics will not under any circumstances whether as a result of breach of contract, breach of warranty, tort, strict liability or otherwise be liable for consequential, incidental, special or exemplary damages including but not limited to, loss of profits or revenues, loss of any other goods or associated equipment or damage to any associated equipment, cost of capital, cost of substitute products, facilities or services, down time cost or claims of claimant's customers. ATG Electronics liability on any claim of any kind for any loss or damages arising out of, resulting from or concerning any LED product, any aspect of this warranty or for any products or services furnished hereunder shall not exceed the price of the fixture which gives rise to the claim.

Return and Repair Procedures

All warranty requests and or questions are to be directed to ATG Electronics Customer Service Department (CSD) at 888-618-7298. If deemed necessary, the CSD will issue a Returned Merchandise Authorization (RMA) number which must be included on both the packing slip of the component or fixture being returned and on the outside of the box. You must include your name and contact information, including your email address, on the packing slip so that we can contact you easily. Each component or fixture must be packaged very carefully and properly so as to prevent damages in shipment and must be shipped freight prepaid. Please obtain a proof of delivery to ensure that the material is received.

Once the component or fixture has been received and tested, an evaluation report will be provided to the end user via email. This report will clarify the following:

- A) The component / fixture is covered under the warranty policy and will either be repaired or replaced.
- B) The component / fixture is not covered under the warranty policy and the reason for this determination.

If ATG ELECTRONICS determines that the component or fixture is covered under the warranty, then the appropriate repairs will be started or a replacement fixture will be manufactured and shipped. Please note that in the event the returned component or fixture is found not to be covered under this warranty, you may be subject to a labor charge for the evaluation process and will be responsible for all return shipping charges and fees. For components and fixtures determined to be covered under this warranty prior to the first anniversary of the Sale Date, the repaired or replacement component or fixture will be returned to you at no charge. You will be responsible for all other shipping charges.

No Labor Reimbursement

All components and fixtures determined to be covered by this warranty as provided above, will be repaired or replaced at no charge to the customer, however, except as expressly provided above with respect to recessed and linear fixtures during the first year, the customer must hire and pay for an electrician to remove and reinstall such components and fixtures. No labor costs will be covered for the removal or reinstallation of any components or fixtures. The warranty does not cover modifications, repairs or replacements, or the related labor or materials costs, that may be necessary to facilities or third party products in connection with the removal, repair, or replacement of any LED product under this warranty.