

**JUNO**

# 2" IC 600 AND 1000 LUMENS LED ROUND DOWNLIGHT BAFFLE

Project: \_\_\_\_\_

Fixture Type: \_\_\_\_\_

Location: \_\_\_\_\_

Contact/Phone: \_\_\_\_\_

**2LEDTRIM G2 DB**

## PRODUCT DESCRIPTION

2 inch aperture recessed downlight is IC rated for insulated or non-insulated applications • Luminaire produces up to 1000 lumens and is available with optical distributions approximating that of 75W MR16 halogen lamps

- Low profile form factor allows luminaire to fit in 2 x 6 construction
- Designed to provide 50,000 hours of life • 5 year limited warranty on LED Components.

## ENVIRONMENTALLY FRIENDLY, ENERGY EFFICIENT

- No harmful ultraviolet or infrared wavelengths
- No lead or mercury, RoHS compliant
- Comparable light output up to a 75W MR16 halogen lamp

## PRODUCT SPECIFICATIONS

**LED Light Engine** Exceptional fixture to fixture color consistency within a 3-step MacAdam ellipse • 2700K, 3000K, 3500K, and 4000K color temperatures are available with 80 CRI or 90 CRI minimum.

**Modular Optics** Available with field interchangeable optics in 18° Spot, 24° Narrow Flood, or 40° Flood distributions.

**Aesthetic Trim** Trim features die cast beveled knife edge trim ring for clean ceiling interface available in white, black, satin nickel, or brushed bronze • Die cast baffles are available in white, black, satin nickel, or brushed bronze

**LED Driver** Choice of dedicated 120 volt (120) driver or universal voltage (MVOLT) driver that accommodates input voltages from 120-277 volts AC at 50/60Hz • Power factor > 0.9 • Dedicated 120 volt driver (120) is dimmable with the use of most incandescent, magnetic low voltage and electronic low voltage dimmers • Universal voltage driver (MVOLT) is dimmable with the use of most 0-10V protocol dimmers

- For a list of compatible dimmers, see [JUNO2ING2-DIM](#).

**Life** Rated for 50,000 hours at 70% lumen maintenance.

**Labels** ENERGY STAR® Certified • 90CRI fixtures are certified to the high efficacy requirements of California T24 JA8-2016 • Meets energy code Air Leakage requirements per ASTM E283 • UL and cUL listed for wet locations • 2NCHSG option is compatible with spray foam insulation with an R-value of 3.2 per inch or less.

**Junction Box** Includes (2) ½" knock-outs equipped with pryout slots

- Push-in electrical connectors for field connections.

**Mounting** Remodel style plaster frame installs from below the ceiling and accommodates ceiling thicknesses from ½" to 1" • For thicker ceilings up to 1 ½", order 2JCTA150 • New Construction mounting frame, 2NCMF, is also available with Patented (US Patent D552,969) Real Nail 3® telescoping bar hangers to position fixture and locate wiring prior to ceiling installation • Recommend a minimum of 5.5" cavity depth to install properly • Flexible supply is recommended and non-flexible supply requires top access.

**Real Nail 3 Bar Hangers** 2NCHSG new construction housing and new construction mounting frame, 2NCMF, available with telescoping Real Nail® 3 system which permits quick placement of housing anywhere within 24" O.C. joists or suspended ceilings • Includes removable nail for repositioning of fixture in wood joist construction • Integral T-bar notch and clip for suspended ceilings • Design covered under US Patent D552,969 • 2NCHSG requires 2x8 construction

Specifications subject to change without notice.



## Downlight Baffle Finishes

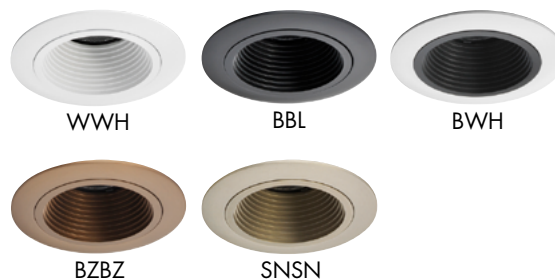

## DIMENSIONS

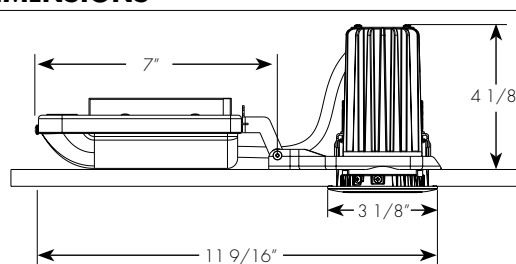

2 5/8" CEILING CUTOUT  
2" APERTURE

## ELECTRICAL DATA (600L)

	Dedicated 120V (120)		Universal Voltage (MVOLT)	
	Voltage	120	120	277
Input Power	7.5 (±5%)	7.2	7.5 (±5%)	
Input Current	.06	.06	.03	
Frequency	50/60Hz		50/60Hz	
Power Factor	>0.9	>0.9	>0.9	

## ELECTRICAL DATA (1000L)

	Dedicated 120V (120)		Universal Voltage (MVOLT)	
	Voltage	120	120	277
Input Power	11.5 (±5%)	10.9	11.4 (±5%)	
Input Current	.10	.09	.04	
Frequency	50/60Hz		50/60Hz	
Power Factor	>0.9	>0.9	>0.9	

# 2" IC 600 AND 1000 LUMENS LED ROUND DOWNLIGHT BAFFLE 2LEDTRIM G2 DB

**ORDERING INFORMATION** DRIVER AND TRIM EACH ORDERED SEPARATELY.

## DRIVER:

Example: 2LEDDRIVER G2 06LM 120 FRPC

Series	Generation	Lumens	Voltage	Driver
2LEDDRIVER Juno Recessed 2" Driver	G2 Generation 2	06LM 600 Nominal Lumens 10LM 1000 Nominal Lumens	120 120V MVOLT Multi-Volt (120-277V)	FRPC Forward/Reverse Phase Cut ZT 0-10V Dimming

Note: 120V must be ordered with FRPC.  
MVOLT must be ordered with ZT

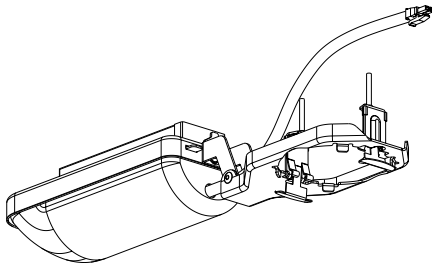

MOUNTING FRAME/DRIVER ASSEMBLY

Note: Driver assembly only intended for use with Gen2 LED trim modules. Not backward compatible with previous generation.

## TRIM:

Example: 2LEDTRIM G2 DB 27K 80CRI FL BBL

Series	Generation	Trim Designation	Color Temperature	CRI	Distribution	Trim Finish
2LEDTRIM Juno Recessed 2" LED Trim	G2 Generation 2	DB Downlight Baffle Trim	27K 2700K 30K 3000K 35K 3500K 40K 4000K	80CRI 80+ CRI 90CRI 90+ CRI	FL Flood NFL Narrow Flood SP Spot	BBL Black Baffle, Black Trim Ring BWH Black Baffle, White Trim Ring BZBZ Bronze Baffle, Bronze Trim Ring SNSN Satin Nickel Baffle, Satin Nickel Trim Ring WWH White Baffle, White Trim Ring

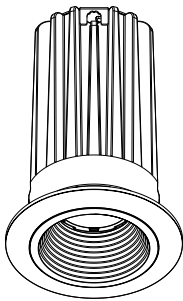

TRIM/LED ASSEMBLY

## ACCESSORIES

Catalog No.	Description
2NCMF	New Construction Mounting Frame with Real Nail® 3 bar hangers
2NCHSG	2" New Construction Housing for spray foam installation
2DTCA	2" LED Drop Tile Ceiling Adapter
2JCTA150	Thick Ceiling adapter for 1" - 1 1/2" thick ceiling
LEDOPTIC2 SP	18° Spot Optic
LEDOPTIC2 NFL	24° Narrow Flood Optic
LEDOPTIC2 FL	40° Flood Optic

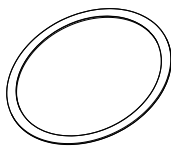

2DTCA

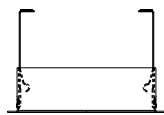

2JCTA150

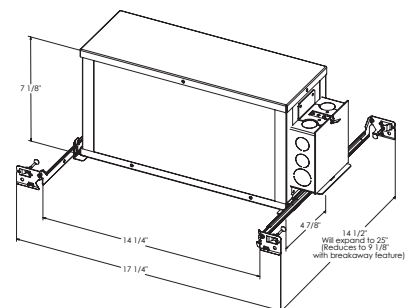
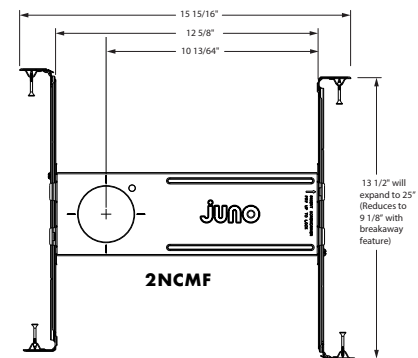
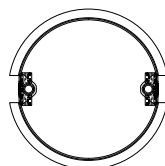

2NCHSG

# 2" IC 600 AND 1000 LUMENS LED ROUND DOWNLIGHT BAFFLE 2LEDTRIM G2 DB

## PHOTOMETRICS

### PHOTOMETRIC REPORT

Test Report#: PTO7161801  
Catalog No: 2LEDTRIM G2 DB 35K 80CRI  
SP WWH (600L), White Baffle  
with Spot Optic  
Luminaire Spacing Criteria: 0.34  
Luminaire LPW: 93

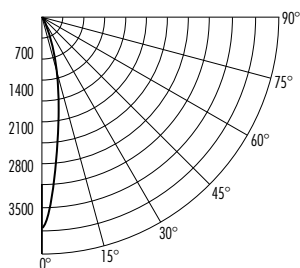

### CANDLEPOWER DISTRIBUTION (Candelas)

Degrees Vertical	0°
0	3492
5	2934
15	926
25	286
35	45
45	16
55	12
65	8
75	4
85	1
90	0

### AVERAGE INITIAL FOOTCANDLES Multiple Units (Square Array, 60'x60' room)

Reflectances: Ceiling 80%, Wall 50%, Floor 20%

Spacing	RCR1	RCR3	RCR5
4'	49	44	41
5'	31	28	26
6'	22	20	18
7'	18	16	15
8'	14	13	12
9'	11	10	9
10'	8	7	7

### INITIAL FOOTCANDLES (One Unit, 7.5W, 18.9° Beam)

Distance to Illuminated Plane (Feet)	Footcandles Beam Center	Beam Diameter
4'	218.3	1.3
6'	97.0	2.0
8'	54.6	2.7
10'	34.9	3.3
12'	24.3	4.0

### ZONAL LUMEN SUMMARY

Zone	Lumens	%Lamp	%Fixture
0-30°	629	N/A	89.9
0-40°	662	N/A	94.6
0-60°	686	N/A	98.2
0-90°	699	N/A	100.0

### LUMINANCE (Average cd/m²)

Degrees	Average Luminance
45°	10385
55°	9995
65°	8744
75°	6956
85°	3805

### PHOTOMETRIC REPORT

Test Report#: PTO7161805  
Catalog No: 2LEDTRIM G2 DB 35K 80CRI  
NFL WWH (600L), White Baffle  
with Narrow Flood Optic  
Luminaire Spacing Criteria: 0.42  
Luminaire LPW: 89

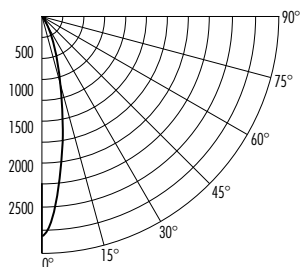

### CANDLEPOWER DISTRIBUTION (Candelas)

Degrees Vertical	0°
0	2532
5	2228
15	926
25	308
35	48
45	17
55	13
65	8
75	4
85	1
90	0

### AVERAGE INITIAL FOOTCANDLES Multiple Units (Square Array, 60'x60' room)

Reflectances: Ceiling 80%, Wall 50%, Floor 20%

Spacing	RCR1	RCR3	RCR5
4'	46	42	38
5'	30	27	24
6'	21	18	17
7'	17	15	14
8'	13	12	11
9'	10	9	8
10'	7	7	6

### INITIAL FOOTCANDLES (One Unit, 7.5W, 24.4° Beam)

Distance to Illuminated Plane (Feet)	Footcandles Beam Center	Beam Diameter
4'	158.3	1.7
6'	70.3	2.6
8'	39.6	3.5
10'	25.3	4.3
12'	17.6	5.2

### ZONAL LUMEN SUMMARY

Zone	Lumens	%Lamp	%Fixture
0-30°	591	N/A	89.0
0-40°	627	N/A	94.4
0-60°	652	N/A	98.1
0-90°	664	N/A	100.0

### LUMINANCE (Average cd/m²)

Degrees	Average Luminance
45°	11256
55°	10325
65°	8744
75°	6773
85°	2718

### PHOTOMETRIC REPORT

Test Report#: PTO7161809  
Catalog No: 2LEDTRIM G2 DB 35K 80CRI  
FL WWH (600L), White Baffle  
with Flood Optic  
Luminaire Spacing Criteria: 0.72  
Luminaire LPW: 94

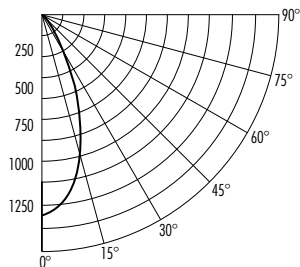

### CANDLEPOWER DISTRIBUTION (Candelas)

Degrees Vertical	0°
0	1187
5	1141
15	879
25	492
35	135
45	27
55	11
65	8
75	4
85	1
90	0

### AVERAGE INITIAL FOOTCANDLES Multiple Units (Square Array, 60'x60' room)

Reflectances: Ceiling 80%, Wall 50%, Floor 20%

Spacing	RCR1	RCR3	RCR5
4'	49	43	38
5'	31	27	24
6'	22	19	17
7'	18	15	14
8'	14	12	11
9'	11	9	8
10'	8	7	6

### INITIAL FOOTCANDLES (One Unit, 7.5W, 44.9° Beam)

Distance to Illuminated Plane (Feet)	Footcandles Beam Center	Beam Diameter
4'	74.2	3.3
6'	33.0	5.0
8'	18.5	6.6
10'	11.9	8.3
12'	8.2	9.9

### ZONAL LUMEN SUMMARY

Zone	Lumens	%Lamp	%Fixture
0-30°	568	N/A	80.9
0-40°	656	N/A	93.3
0-60°	689	N/A	98.0
0-90°	703	N/A	100.0

### LUMINANCE (Average cd/m²)

Degrees	Average Luminance
45°	18024
55°	9169
65°	9193
75°	8054
85°	4349

Fixtures tested to IES recommended standard for solid state lighting per LM-79-08. Photometric performance on a single unit represents a baseline of performance for the fixture. Results may vary in the field.

Multiplier:	80CRI	90CRI
	27K = .94	27K = .83
	30K = .97	30K = .86
	35K = 1.00	35K = .88
	40K = 1.03	40K = .90

# 2" IC 600 AND 1000 LUMENS LED ROUND DOWNLIGHT BAFFLE 2LEDTRIM G2 DB

## PHOTOMETRICS

### PHOTOMETRIC REPORT

Test Report#: PT07161913  
 Catalog No: 2LEDTRIM G2 DB 35K 80CRI  
 SP WWH (1000L), White Baffle  
 with Spot Optic  
 Luminaire Spacing Criteria: 0.32  
 Luminaire LPW: 92

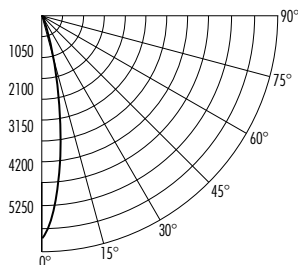

### CANDLEPOWER DISTRIBUTION (Candelas)

Degrees Vertical	0°
0	5297
5	4423
15	1390
25	434
35	69
45	25
55	19
65	13
75	6
85	1
90	0

### AVERAGE INITIAL FOOTCANDLES

Multiple Units (Square Array, 60'x60' room)  
 Reflectances: Ceiling 80%, Wall 50%, Floor 20%

Spacing	RCR1	RCR3	RCR5
4'	74	67	61
5'	47	43	39
6'	33	30	27
7'	27	24	22
8'	21	19	17
9'	16	15	13
10'	12	11	10

### INITIAL FOOTCANDLES

(One Unit, 11.5W, 18.6° Beam)

Distance to Illuminated Plane (Feet)	Footcandles Beam Center	Beam Diameter
4'	331.1	1.3
6'	147.1	2.0
8'	82.8	2.6
10'	53.0	3.3
12'	36.8	3.9

### LUMINANCE (Average cd/m²)

Degrees	Average Luminance
45°	16550
55°	15859
65°	14013
75°	11532
85°	7610

### PHOTOMETRIC REPORT

Test Report#: PT07161917  
 Catalog No: 2LEDTRIM G2 DB 35K 80CRI  
 NFL WWH (1000L), White Baffle  
 with Narrow Flood Optic  
 Luminaire Spacing Criteria: 0.42  
 Luminaire LPW: 88

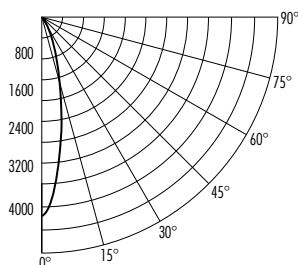

### CANDLEPOWER DISTRIBUTION (Candelas)

Degrees Vertical	0°
0	3827
5	3375
15	1423
25	469
35	73
45	25
55	19
65	12
75	6
85	1
90	0

### AVERAGE INITIAL FOOTCANDLES

Multiple Units (Square Array, 60'x60' room)  
 Reflectances: Ceiling 80%, Wall 50%, Floor 20%

Spacing	RCR1	RCR3	RCR5
4'	71	63	58
5'	45	40	37
6'	31	28	26
7'	25	23	21
8'	20	18	17
9'	15	14	13
10'	11	10	9

### INITIAL FOOTCANDLES

(One Unit, 11.5W, 24.6° Beam)

Distance to Illuminated Plane (Feet)	Footcandles Beam Center	Beam Diameter
4'	239.1	1.7
6'	106.3	2.6
8'	59.8	3.5
10'	38.3	4.4
12'	26.6	5.2

### LUMINANCE (Average cd/m²)

Degrees	Average Luminance
45°	16818
55°	15281
65°	13228
75°	10617
85°	6523

### PHOTOMETRIC REPORT

Test Report#: PT07161921  
 Catalog No: 2LEDTRIM G2 DB 35K 80CRI  
 FL WWH (1000L), White Baffle  
 with Flood Optic  
 Luminaire Spacing Criteria: 0.72  
 Luminaire LPW: 94

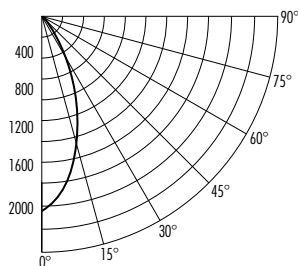

### CANDLEPOWER DISTRIBUTION (Candelas)

Degrees Vertical	0°
0	1822
5	1752
15	1351
25	757
35	208
45	42
55	17
65	13
75	7
85	2
90	0

### AVERAGE INITIAL FOOTCANDLES

Multiple Units (Square Array, 60'x60' room)  
 Reflectances: Ceiling 80%, Wall 50%, Floor 20%

Spacing	RCR1	RCR3	RCR5
4'	75	66	58
5'	48	42	37
6'	33	29	26
7'	27	24	21
8'	21	19	17
9'	16	14	13
10'	12	10	9

### INITIAL FOOTCANDLES

(One Unit, 11.5W, 45° Beam)

Distance to Illuminated Plane (Feet)	Footcandles Beam Center	Beam Diameter
4'	113.9	3.3
6'	50.6	5.0
8'	28.5	6.6
10'	18.2	8.3
12'	12.7	9.9

### LUMINANCE (Average cd/m²)

Degrees	Average Luminance
45°	28007
55°	14373
65°	14686
75°	13180
85°	9785

Fixtures tested to IES recommended standard for solid state lighting per LM-79-08. Photometric performance on a single unit represents a baseline of performance for the fixture. Results may vary in the field.

Multiplier:	80CRI	90CRI
	27K = .94	27K = .83
	30K = .97	30K = .86
	35K = 1.00	35K = .88
	40K = 1.03	40K = .90